

COB LED STRIP PLUS

PRODUCT SPECIFICATION

COB LED STRIP PLUS



More extreme vision

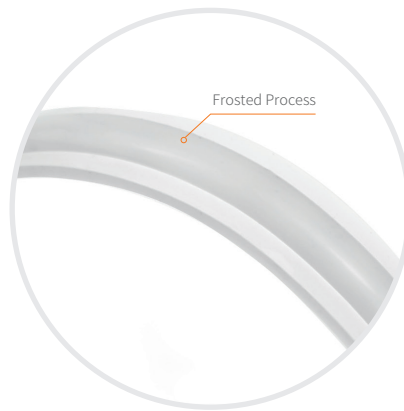

More perfect touch

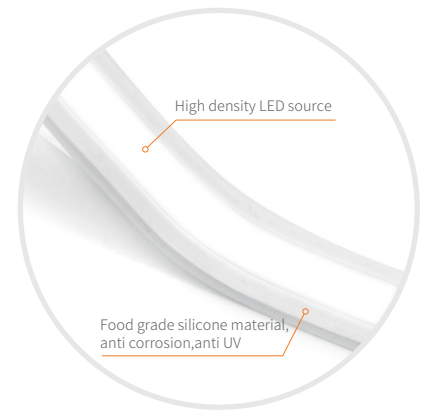

More stable performance

Specialized
LED strip
Manufacturer

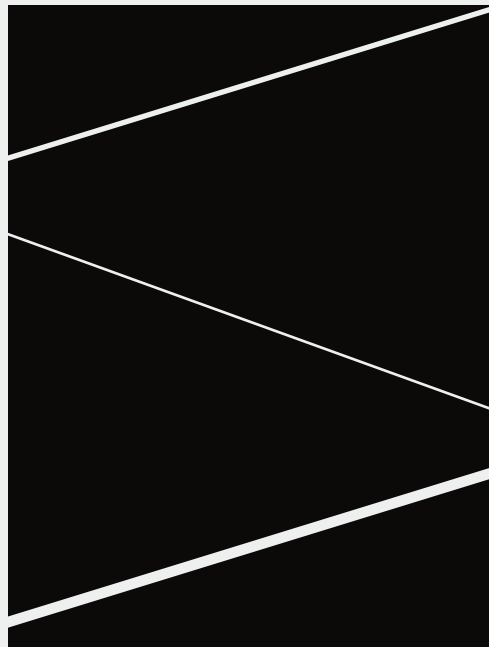

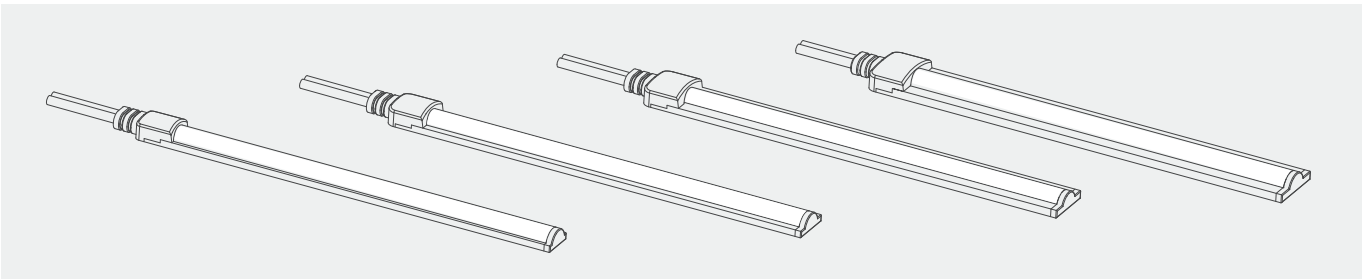

8MM

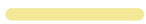

Single Color

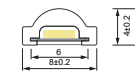

Cross section



Max.Length:5M



IP65



Cable Type

10MM



Single Color /Dual-White
RGB/Digital RGB

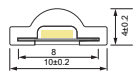

Cross section



Max.Length:5M



IP65



Cable Type

12MM



Single Color /Dual-White
RGB/Digital RGB

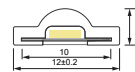

Cross section



Max.Length:5M



IP65



Cable Type

14MM



Single Color /Dual-White/RGB
RGBW/RGBWW/Digital RGB

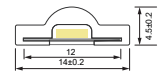

Cross section



Max.Length:5M



IP65



Cable Type

Dimension structure

8MM

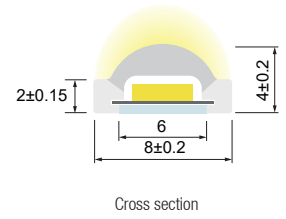
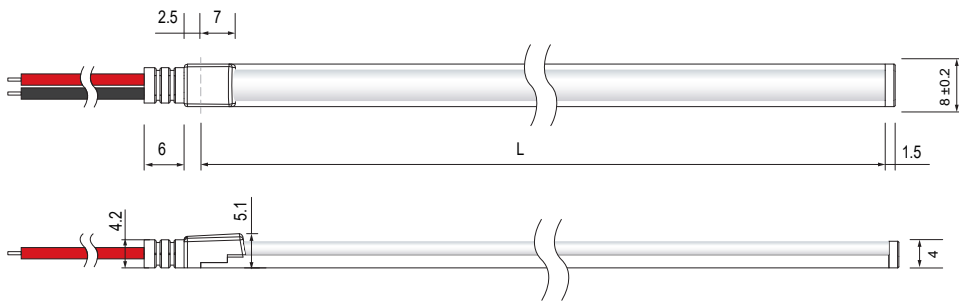

10MM

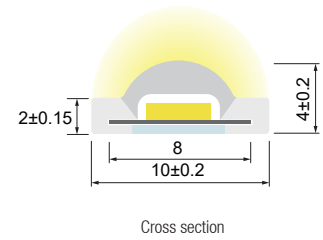
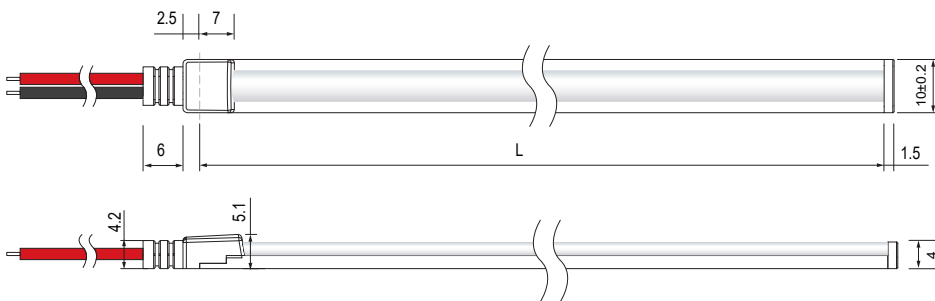

12MM

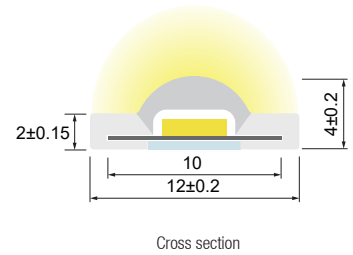
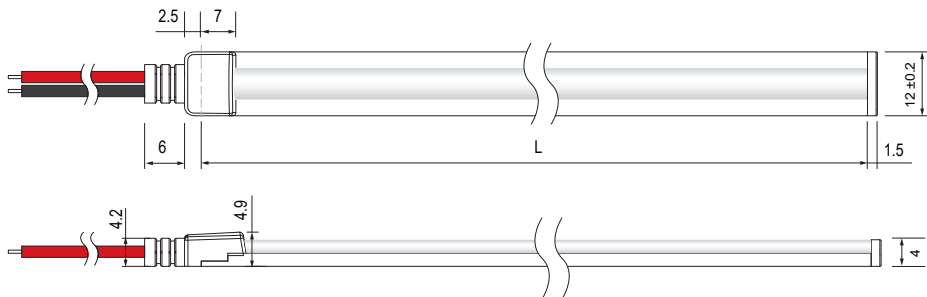

14MM

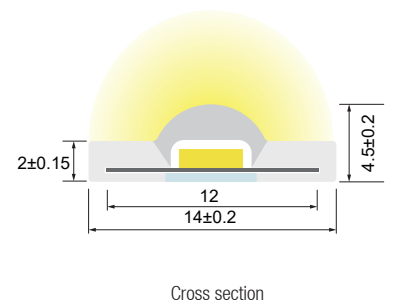
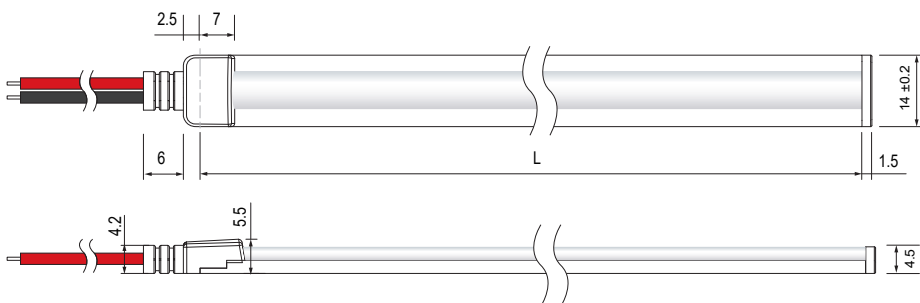

Parameter Table For 8MM

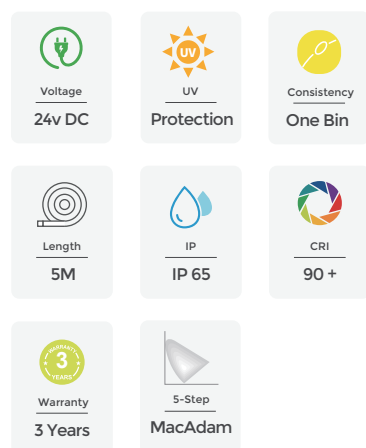

- The maximum series length refers to the maximum single end power supply length of the constant current strip under the condition of standard 5m wire .
- The given color temperature is the temperature of finished product.
- The given data are typical values due to the tolerances of the production process and the electrical components, values for light output and electrical power can vary up to 10%.

Single-Color

CCT(K)	CRI	SDCM	Power(W)	Lumen (LM/M)	Efficiency (LM/W)	Unit Length (mm)	Max. Run Length (M)	Voltage
2400	>90	<5	5	535	107.1	50	5	DC24V
			10	1010	101			
2700	>90	<5	5	546	109.2	50	5	DC24V
			10	1019	101.9			
3000	>90	<5	5	554	110.9	50	5	DC24V
			10	1046	104.6			
3500	>90	<5	5	599	119.8	50	5	DC24V
			10	1130	113			
4000	>90	<5	5	558	111.7	50	5	DC24V
			10	1077	107.7			
5000	>90	<5	5	552	110.4	50	5	DC24V
			10	1028	102.8			
6500	>90	<5	5	560	111.9	50	5	DC24V
			10	1056	105.6			
R	--	--	5	145	29.0	50	5	DC24V
			10	293	29.3			
G	--	--	5	381	76.2	50	5	DC24V
			10	685	68.5			
B	--	--	5	71	14.2	50	5	DC24V
			10	134	13.4			
Yellow	--	--	5	116	23.2	50	5	DC24V
			10	223	22.3			
Orange	--	--	5	136	27.2	50	5	DC24V
			10	274	27.4			
Pink	--	--	5	315	63	50	5	DC24V
			10	602	60.2			

* This maximum serial length refers to the recommended connection length of single-end power supply when the COB strip is fully loaded (RGB all on). In practical application, according to the final required effect, when the actual required power is small, the serial length can be extended as appropriate.

Parameter Table For 10MM

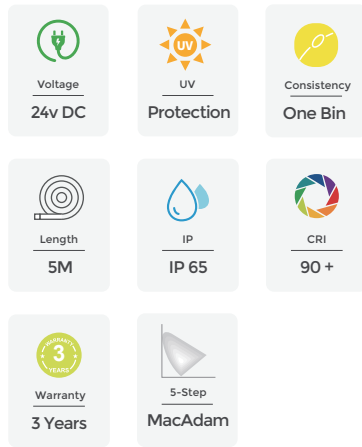

- The maximum series length refers to the maximum single end power supply length of the constant current strip under the condition of standard 5m wire .
- The given color temperature is the temperature of finished product.
- The given data are typical values due to the tolerances of the production process and the electrical components, values for light output and electrical power can vary up to 10%.

Single-Color

CCT(K)	CRI	SDCM	Power(W)	Lumen (LM/M)	Efficiency (LM/W)	Unit Length (mm)	Max. Run Length (M)	Voltage
2400	>90	<5	5	409	81.9	25	5	DC24V
			10	815	81.5			
2700	>90	<5	5	423	84.6	25	5	DC24V
			10	822	82.2			
3000	>90	<5	5	422	84.4	25	5	DC24V
			10	829	82.9			
3500	>90	<5	5	476	95.2	25	5	DC24V
			10	918	91.8			
4000	>90	<5	5	439	87.9	25	5	DC24V
			10	866	86.6			
5000	>90	<5	5	443	88.5	25	5	DC24V
			10	869	86.9			
6500	>90	<5	5	453	90.6	25	5	DC24V
			10	886	88.6			
R	--	--	5	146	29.2	25	5	DC24V
			10	308	30.8			
G	--	--	5	413	82.6	25	5	DC24V
			10	707	70.7			
B	--	--	5	70	14	25	5	DC24V
			10	137	13.7			
Yellow	--	--	5	106	21.2	25	5	DC24V
			10	226	22.6			
Orange	--	--	5	128	25.6	25	5	DC24V
			10	278	27.8			
Pink	--	--	5	287	57.4	25	5	DC24V
			10	567	56.7			

Dual-White

CCT(K)	CRI	SDCM	Power(W)	Lumen (LM/M)	Efficiency (LM/W)	Unit Length (mm)	Max. Run Length(M)	Voltage
2700	>90	<5	5	415	83.0	83.3	5	DC24V
6500			5	418	83.6			
4000±300			10	826	82.6			

RGB

Power(W)	Color	Lumen(LM/M)	Efficiency(LM/W)	Unit Length (mm)	Max. Run Length(M)	Voltage
10	R	60	18.2	50	5	DC24V
	G	176	53.3			
	B	32	9.7			
	RGB	268	26.8			

Digital RGB

Voltage (V)	Power(W)	Color	Lumen (LM/M)	Efficiency (LM/W)	Pixel (PCS)	Signal Type	IC Model	UnitLength (mm)	Max. Run Length(M)
5	8	R	19.8	7.4	100	SPI	UCS1903	10	2
		G	59.3	22.2					
		B	11.5	4.3					
		RGB	87.3	10.9					

* This maximum serial length refers to the recommended connection length of single-end power supply when the COB strip is fully loaded (RGB all on). In practical application, according to the final required effect, when the actual required power is small, the serial length can be extended as appropriate.

Parameter Table For 12MM

Single-Color

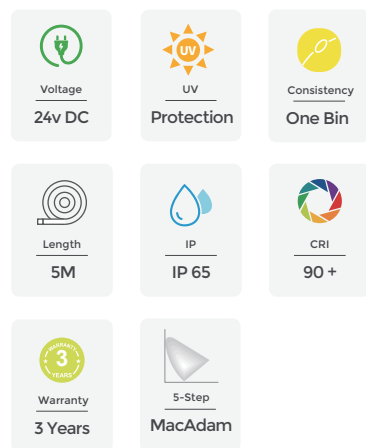

- The maximum series length refers to the maximum single end power supply length of the constant current strip under the condition of standard 5m wire .
- The given color temperature is the temperature of finished product.
- The given data are typical values due to the tolerances of the production process and the electrical components, values for light output and electrical power can vary up to 10%.

CCT(K)	CRI	SDCM	Power(W)	Lumen (LM/M)	Efficiency (LM/W)	Unit Length (mm)	Max. Run Length (M)	Voltage
2400	>90	<5	5	429	85.9	25	5	DC24V
			10	826	82.6			
			15	1208	80.6			
2700	>90	<5	5	433	86.6	25	5	DC24V
			10	833	83.3			
			15	1244	82.9			
3000	>90	<5	5	436	87.3	25	5	DC24V
			10	840	84			
			15	1243	82.8			
3500	>90	<5	5	484	96.7	25	5	DC24V
			10	930	93			
			15	1364	91			
4000	>90	<5	5	442	88.4	25	5	DC24V
			10	851	85.1			
			15	1258	83.9			
5000	>90	<5	5	443	88.7	25	5	DC24V
			10	854	85.4			
			15	1259	84			
6500	>90	<5	5	450	90	25	5	DC24V
			10	867	86.7			
			15	1270	84.6			
R	--	--	5	142	28.4	25	5	DC24V
			10	281	28.1			
			15	416	27.7			
G	--	--	5	349	69.8	25	5	DC24V
			10	628	62.8			
			15	823	54.9			
B	--	--	5	62	12.4	25	5	DC24V
			10	121	12.1			
			15	176	11.7			
Yellow	--	--	5	88	17.6	25	5	DC24V
			10	200	20			
			15	294	19.6			
Orange	--	--	5	108	21.6	25	5	DC24V
			10	246	24.6			
			15	345	23			
Pink	--	--	5	274	54.8	25	5	DC24V
			10	519	51.9			
			15	755	50.3			

Parameter Table For 12MM

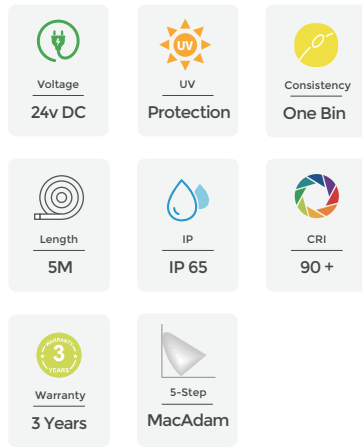

- The maximum series length refers to the maximum single end power supply length of the constant current strip under the condition of standard 5m wire .
- The given color temperature is the temperature of finished product.
- The given data are typical values due to the tolerances of the production process and the electrical components, values for light output and electrical power can vary up to 10%.

Dual-White

CCT(K)	CRI	SDCM	Power(W)	Lumen (LM/M)	Efficiency (LM/W)	Unit Length (mm)	Max. Run Length(M)	Voltage
2700	>90	<5	5	422	84.4	83.3	5	DC24V
6500			5	434	86.8			
4000±300			10	849	84.9			
2700	>90	<5	7.5	619	82.5	83.3	5	DC24V
6500			7.5	639	85.2			
4000±300			15	1241	82.7			

RGB









Power(W)	Color	Lumen(LM/M)	Efficiency(LM/W)	Unit Length (mm)	Max. Run Length(M)	Voltage
10	R	54	16.4	50	5	DC24V
	G	175	53.0			
	B	31	9.4			
	RGB	264	26.4			
15	R	76	15.2	50	5	DC24V
	G	233	46.6			
	B	39	7.8			
	RGB	339	22.6			

Digital RGB

Voltage (V)	Power(W)	Color	Lumen (LM/M)	Efficiency (LM/W)	Pixel (PCS)	Signal Type	IC Model	UnitLength (mm)	Max. Run Length(M)
12	13	R	42.6	3.3	100	SPI	UCS1903	10	3
		G	141.6	10.9					
		B	33	2.5					
		RGB	208.5	16.0					

* This maximum serial length refers to the recommended connection length of single-end power supply when the COB strip is fully loaded (RGB all on). In practical application, according to the final required effect, when the actual required power is small, the serial length can be extended as appropriate.

Parameter Table For 14MM

 Voltage 24v DC	 UV Protection	 Consistency One Bin
 Length 5M	 IP IP 65	 CRI 90 +
 Warranty 3 Years	 5-Step MacAdam	

- The maximum series length refers to the maximum single end power supply length of the constant current strip under the condition of standard 5m wire .
- The given color temperature is the temperature of finished product.
- The given data are typical values due to the tolerances of the production process and the electrical components, values for light output and electrical power can vary up to 10%.









Single-Color

CCT(K)	CRI	SDCM	Power(W)	Lumen (LM/M)	Efficiency (LM/W)	Unit Length (mm)	Max. Run Length (M)	Voltage
2400	>90	<5	5	449	89.8	25	5	DC24V
			10	845	84.5			
			15	1234	82.3			
2700	>90	<5	5	445	89.1	25	5	DC24V
			10	853	85.3			
			15	1272	84.8			
3000	>90	<5	5	444	88.7	25	5	DC24V
			10	858	85.8			
			15	1271	84.7			
3500	>90	<5	5	489	97.7	25	5	DC24V
			10	950	95			
			15	1399	93.2			
4000	>90	<5	5	449	89.9	25	5	DC24V
			10	862	86.2			
			15	1273	84.9			
5000	>90	<5	5	453	90.6	25	5	DC24V
			10	869	86.9			
			15	1283	85.5			
6500	>90	<5	5	458	91.6	25	5	DC24V
			10	879	87.9			
			15	1298	86.5			
R	--	--	5	142	28.4	25	5	DC24V
			10	282	28.2			
			15	420	28			
G	--	--	5	375	75	25	5	DC24V
			10	674	67.4			
			15	882	58.8			
B	--	--	5	70	14	25	5	DC24V
			10	123	12.3			
			15	179	11.9			
Yellow	--	--	5	116	23.2	25	5	DC24V
			10	223	22.3			
			15	318	21.2			
Orange	--	--	5	140	28	25	5	DC24V
			10	274	27.4			
			15	386	25.7			
Pink	--	--	5	287	57.4	25	5	DC24V
			10	534	53.4			
			15	782	52.1			

Dual-White

CCT(K)	CRI	SDCM	Power(W)	Lumen (LM/M)	Efficiency (LM/W)	Unit Length (mm)	Max. Run Length (M)	Voltage
2700	>90	<5	5	437	87.4	83.3	5	DC24V
6500			5	447	89.4			
4000±300			10	860	86			
2700	>90	<5	7.5	641	85.5	83.3	5	DC24V
6500			7.5	658	87.7			
4000±300			15	1264	84			

Parameter Table For 14MM

 Voltage 24v DC	 UV Protection	 Consistency One Bin
 Length 5M	 IP IP 65	 CRI 90 +
 Warranty 3 Years	 5-Step MacAdam	

- The maximum series length refers to the maximum single end power supply length of the constant current strip under the condition of standard 5m wire .
- The given color temperature is the temperature of finished product.
- The given data are typical values due to the tolerances of the production process and the electrical components, values for light output and electrical power can vary up to 10%.







RGB

Power(W)	Color	Lumen(LM/M)	Efficiency(LM/W)	Unit Length (mm)	Max. Run Length(M)	Voltage
10	R	49	14.8	50	5	DC24V
	G	169	51.2			
	B	30	9.1			
	RGB	260	26.0			
15	R	69	13.8	50	5	DC24V
	G	226	45.2			
	B	38	7.6			
	RGB	334	22.3			

RGBW

Total Power(W)	CCT/Color	CRI	SDCM	Power for single color(W)	Lumen (LM/M)	Efficiency (LM/W)	Unit Length (mm)	Max. Run Length(M)	Voltage
15	R	--	--	3	52	17.3	83.33	5	DC24V
	G	--	--	3	156	52.0			
	B	--	--	3	26	8.7			
	W: 2700K	>90	5	6	486	81.0			
	RGBW	--	--	15	702	46.8			
15	R	--	--	3	58	19.3	83.33	5	DC24V
	G	--	--	3	173	57.7			
	B	--	--	3	23	7.7			
	W: 3000K	>90	5	6	480	80.0			
	RGBW	--	--	15	698	46.5			
15	R	--	--	3	56	18.7	83.33	5	DC24V
	G	--	--	3	162	54.0			
	B	--	--	3	32	10.7			
	W: 3500K	>90	5	6	514	85.7			
	RGBW	--	--	15	706	47.1			
15	R	--	--	3	55	18.3	83.33	5	DC24V
	G	--	--	3	158	52.7			
	B	--	--	3	33	11.0			
	W: 4000K	>90	5	6	477	79.5			
	RGBW	--	--	15	701	46.7			
15	R	--	--	3	54	18.0	83.33	5	DC24V
	G	--	--	3	165	55.0			
	B	--	--	3	32	10.7			
	W: 5000K	>90	5	6	487	81.2			
	RGBW	--	--	15	721	48.1			
15	R	--	--	3	52	17.3	83.33	5	DC24V
	G	--	--	3	167	55.7			
	B	--	--	3	32	10.7			
	W: 6500K	>90	5	6	486	81.0			
	RGBW	--	--	15	716	47.7			

Parameter Table For 14MM

 Voltage 24v DC	 UV Protection	 Consistency One Bin
 Length 5M	 IP IP 65	 CRI 90 +
 Warranty 3 Years		

- The maximum series length refers to the maximum single end power supply length of the constant current strip under the condition of standard 5m wire .
- The given color temperature is the temperature of finished product.
- The given data are typical values due to the tolerances of the production process and the electrical components, values for light output and electrical power can vary up to 10%.

RGBWW





Total Power(W)	CCT/Color	CRI	Power for single color(W)	Lumen (LM/M)	Efficiency (LM/W)	Unit Length (mm)	Max. Run Length(M)	Voltage
9	R	--	3	58	19.3	71.4	5	DC24V
	G	--	3	171	57			
	B	--	3	33	11			
	RGB	--	9	248	27.6			
10	2700K±100K	>90	5	360	72			
	5500K±300K	>90	5	357	71.4			
	3800K±200K	>90	10	722	72.2			

Digital RGB

Voltage (V)	Power(W)	Color	Lumen (LM/M)	Efficiency (LM/W)	Pixel (PCS)	Signal Type	IC Model	UnitLength (mm)	Max. Run Length(M)
12	13	R	44.4	3.4	100	SPI	UCS1903	10	3
		G	143	11.0					
		B	33.5	2.6					
		RGB	210	16.2					

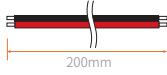
* This maximum serial length refers to the recommended connection length of single-end power supply when the COB strip is fully loaded (RGB all on). In practical application, according to the final required effect, when the actual required power is small, the serial length can be extended as appropriate.

Cable Type

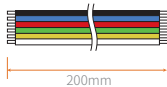
Cable Type	Schematic Diagram	Specification	Core	Electrical Properties
		20AWG Red&Black 2-core Cable	● ●	Red V+, Black V-
		20AWG Brown&White&Yellow 3-core Cable	● ○ ●	Dual-White: Brown V+, White W, Yellow WW
		20AWG Red&Green&Black 3-core Cable	● ● ●	Digital RGB: Red V+, Green DI, Black GND
PVC Cable		20AWG Black&Blue&Red&Green 4-core Cable	● ● ● ●	Black V+, Blue B, Red R, Green G
		20AWG Black&White&Blue&Green &Red 5-core Cable	● ○ ● ● ●	Black V+, White W, Blue B, GreenG, RedR
		20AWG Black&Blue&Red&Green &Yellow&White 6-core Cable	● ● ● ● ● ○	Black V+, Blue B, Red R, Green G, Yellow WW, White W

Cutting Mark



Remark: The bottom of the led strip has transparent window, the black marker is the cutting position



Use professional scissors to cut vertically at the cutting mark

Clip

C8 Clip

8MM

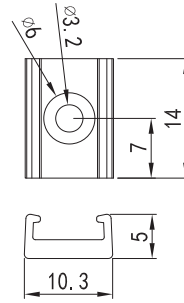

Dimension: :
14x10.3x5
Accessories:
PA 3X10 Self tapping screw

C10 Clip

10MM

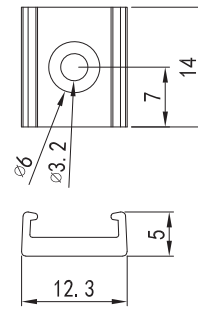
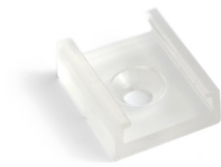

Dimension:
14x12.3x5
Accessories:
PA 3X10 Self tapping screw

C12 Clip

12MM

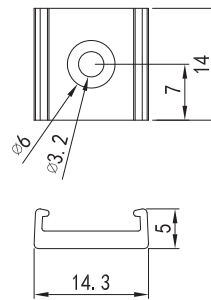

Dimension:
14x14.3x5
Accessories:
PA 3X10 Self tapping screw

C14 Clip

14MM

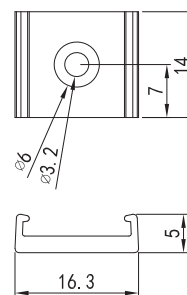

Dimension:
14x16.3x5
Accessories:
PA 3X10 Self tapping screw

Aluminium profile

P8 Aluminium Profile

8MM Profile

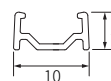
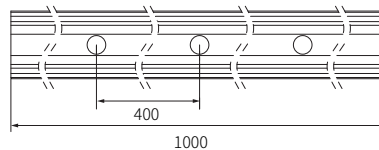

Dimension:
1000x10x5mm
Accessories:
Screw M2.5X15mm

P10 Aluminium Profile

10MM Profile

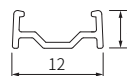
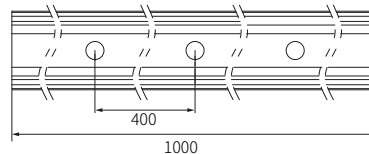

Dimension:
1000x12x5
Accessories:
Screw M2.5X15mm

P12 Aluminium Profile

12MM Profile

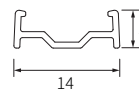
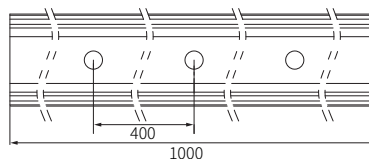

Dimension:
1000x14x5
Accessories:
Screw M2.5X15mm

P14 Aluminium Profile

14MM Profile

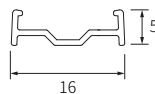
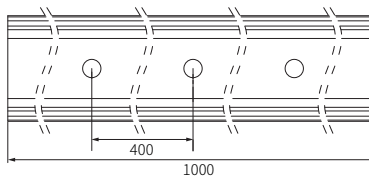

Dimension:
1000x16x5
Accessories:
Screw M2.5X15mm

Quick Connector (Note: The maximum carrying current is 5A; The waterproof grade is reduced to IP20 after using the quick connector)

10mm Quick Connector

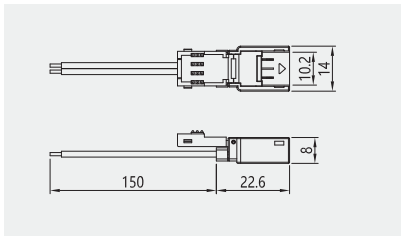

Single color (Red&Black 2-core Cable, Red V+, Blck V-)
CCT Tunable (Brown&White&Yellow 3-core Cable, Brown V+, White W, Yellow WW)
Digital RGB (Red&Green&Black 3-core Cable, Red V+, Green DI, Black GND)

12mm Quick Connector

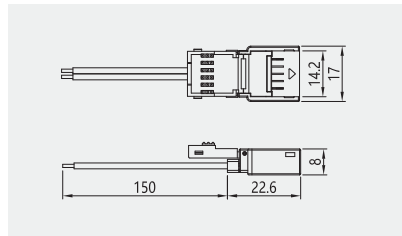

Single color (Red&Black 2-core Cable, Red V+, Black V-)
CCT Tunable (Brown&White&Yellow 3-core Cable, Brown V+, White W, Yellow WW)
Digital RGB (Red&Green&Black 3-core Cable, Red V+, Green DI, Black GND)
R G B (Black&Blue&Red&Green 4-core Cable, Black V+, BlueB, Red R, Green G)

14mm Quick Connector

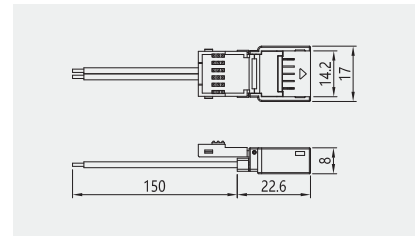

Single color (Red&Black 2-core Cable, Red V+, Black V-)
CCT Tunable (Brown&White&Yellow 3-core Cable, Brown V+, White W, Yellow WW)
Digital RGB (Red&Green&Black 3-core Cable, Red V+, Green DI, Black GND)
R G B (Black&Blue&Red&Green 4-core Cable, Black V+, BlueB, Red R, Green G)
RGBW (Black&White&Blue&Green&Red 5-core Cable, Black V+, White W, Blue B, Green G, Red R)

Quick Connector (Note: The maximum carrying current is 5A; The waterproof grade is reduced to IP20 after using the quick connector)

10mm Quick Connector

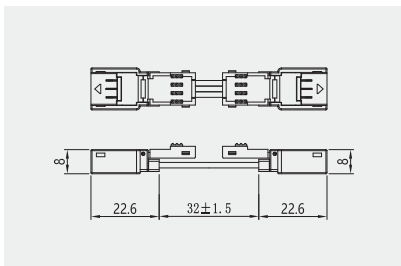

Single color (Red&Black 2-core Cable, Red V+, Blck V-)
CCT Tunable (Brown&White&Yellow 3-core Cable, Brown V+, White W, Yellow WW)
Digital RGB (Red&Green&Black 3-core Cable, Red V+, Green DI, Black GND)

12mm Quick Connector

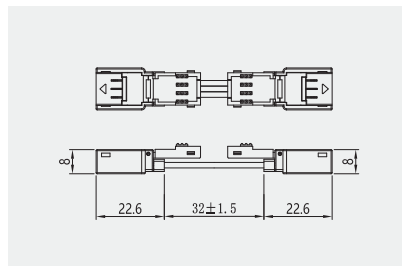

Single color (Red&Black 2-core Cable, Red V+, Black V-)
CCT Tunable (Brown&White&Yellow 3-core Cable, Brown V+, White W, Yellow WW)
Digital RGB (Red&Green&Black 3-core Cable, Red V+, Green DI, Black GND)
R G B (Black&Blue&Red&Green 4-core Cable, Black V+, BlueB, Red R, Green G)

14mm Quick Connector

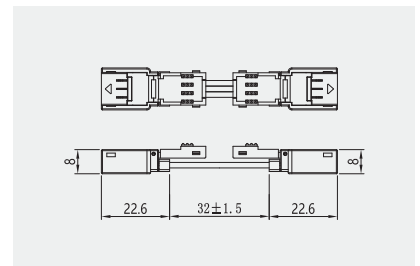

Single color (Red&Black 2-core Cable, Red V+, Black V-)
CCT Tunable (Brown&White&Yellow 3-core Cable, Brown V+, White W, Yellow WW)
Digital RGB (Red&Green&Black 3-core Cable, Red V+, Green DI, Black GND)
R G B (Black&Blue&Red&Green 4-core Cable, Black V+, BlueB, Red R, Green G)
RGBW (Black&White&Blue&Green&Red 5-core Cable, Black V+, White W, Blue B, Green G, Red R)

Quick Connector (Note: The maximum carrying current is 5A; The waterproof grade is reduced to IP20 after using the quick connector)

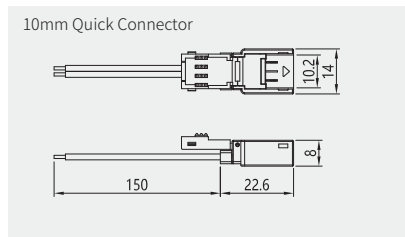

10mm Quick Connector
Single color (Red&Black 2-core Cable, Red V+, Black V-)
CCT Tunable (Brown&White&Yellow 3-core Cable, Brown V+, White W, Yellow WW)
Digital RGB (Red&Green&Black 3-core Cable, Red V+, Green DI, Black GND)

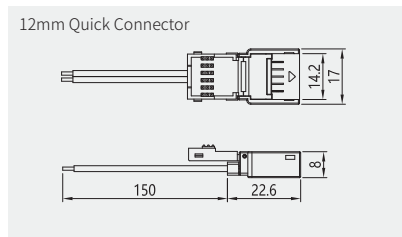

12mm Quick Connector
Single color (Red&Black 2-core Cable, Red V+, Black V-)
CCT Tunable (Brown&White&Yellow 3-core Cable, Brown V+, White W, Yellow WW)
Digital RGB (Red&Green&Black 3-core Cable, Red V+, Green DI, Black GND)
R G B (Black&Blue&Red&Green 4-core Cable, Black V+, BlueB, Red R, Green G)

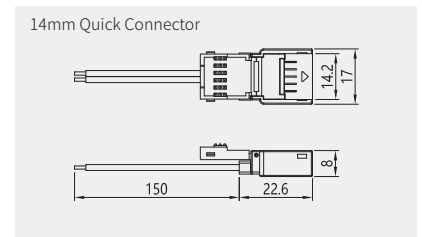

14mm Quick Connector
Single color (Red&Black 2-core Cable, Red V+, Black V-)
CCT Tunable (Brown&White&Yellow 3-core Cable, Brown V+, White W, Yellow WW)
Digital RGB (Red&Green&Black 3-core Cable, Red V+, Green DI, Black GND)
R G B (Black&Blue&Red&Green 4-core Cable, Black V+, BlueB, Red R, Green G)
RGBW (Black&White&Blue&Green&Red 5-core Cable, Black V+, White W, Blue B, Green G, Red R)

Installation Diagram

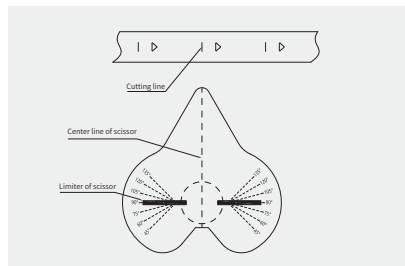

1. Align the scissor with the cutting line on the back of the cob strip.

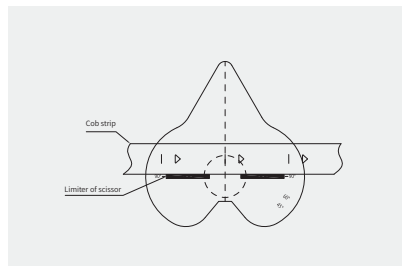

2. Place the cob strip parallel to the scissor and cut the cob strip neatly.

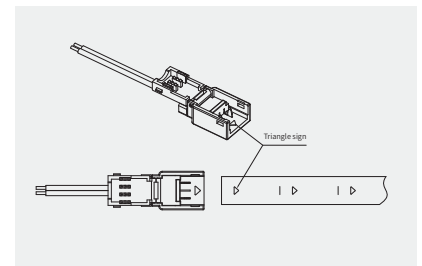

3. Align the triangle sign on the cob strip with that on the quick connector. (Note: The directions of the two triangle signs must be consistent to avoid short circuit.)

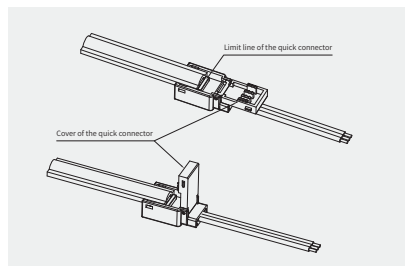

4. Align the cob strip with the limit line on the quick connector, and then press the cover until you hear the click sound.

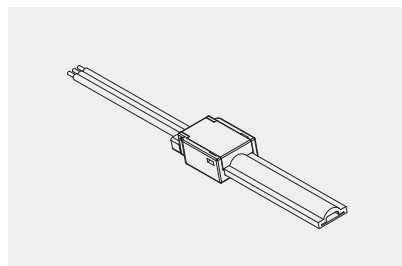

5. Schematic diagram of installation completion.

Disassembly Diagram

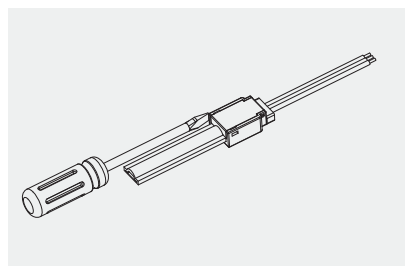

1. Use a flat-head screwdriver to pry the side of the quick connector along the side gap, and then pry another side.

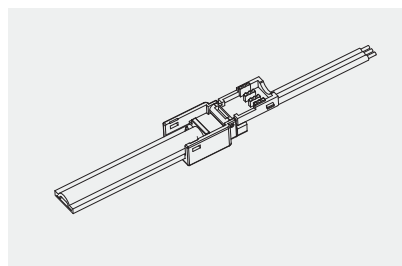

2. Open the cover and remove the cob strip from the needle. Note: When the removed cob strip is used again, the unit length of cob strip that FPCB has been punctured must be cut off to avoid poor contact during reinstallation.

Disassembly Diagram

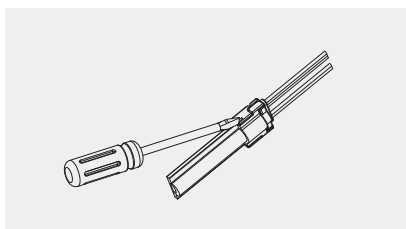

1. Use a flat-head screwdriver to pry the side of the quick connector II along the side gap, and then pry another side.

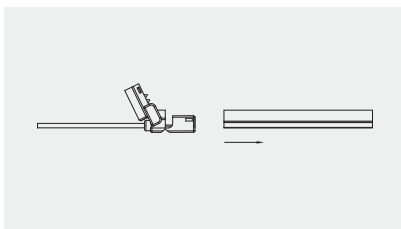

2. Open the top cover of the connector and pull out the COB PLUS strip.

Single Color Connection Diagram

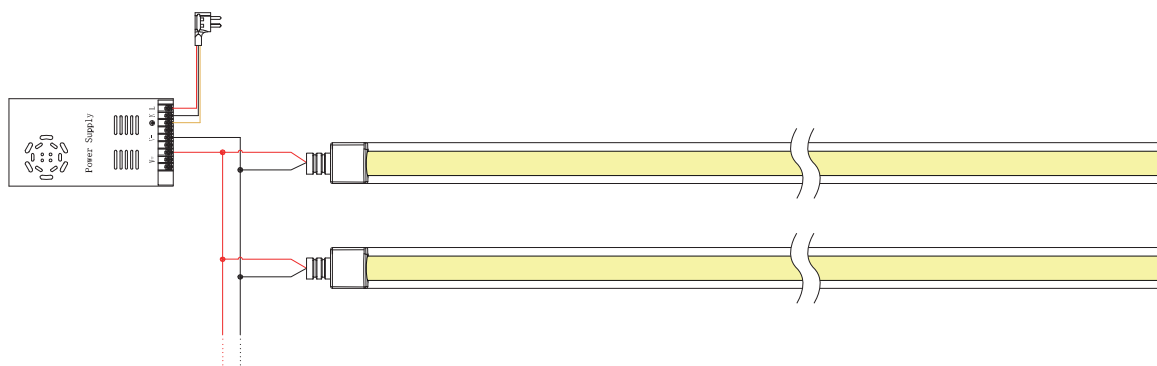

Tunable white Connection Diagram

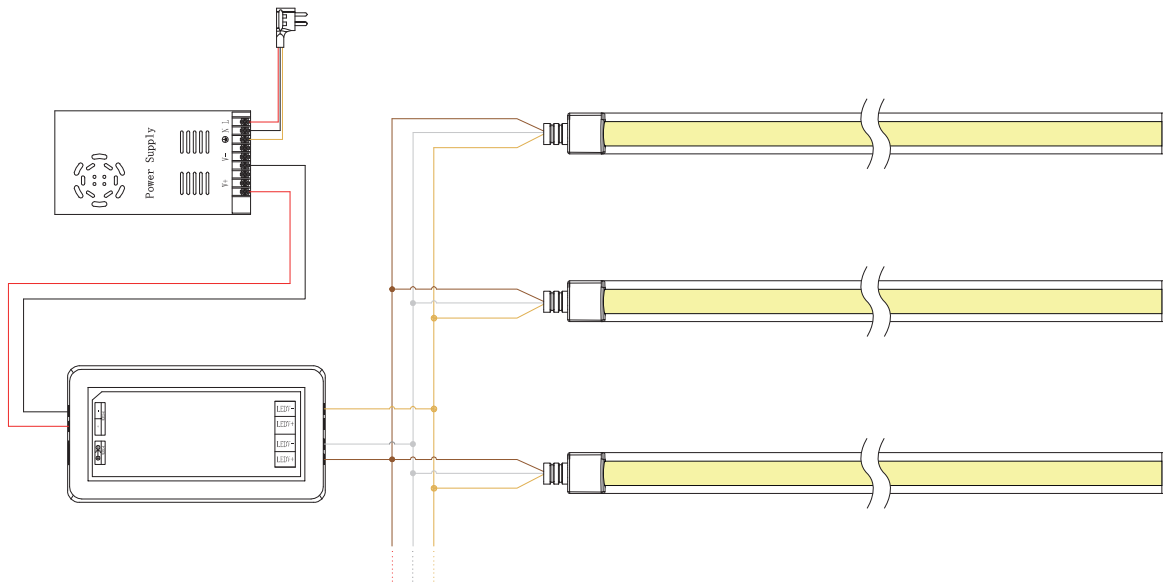

RGB Connection Diagram

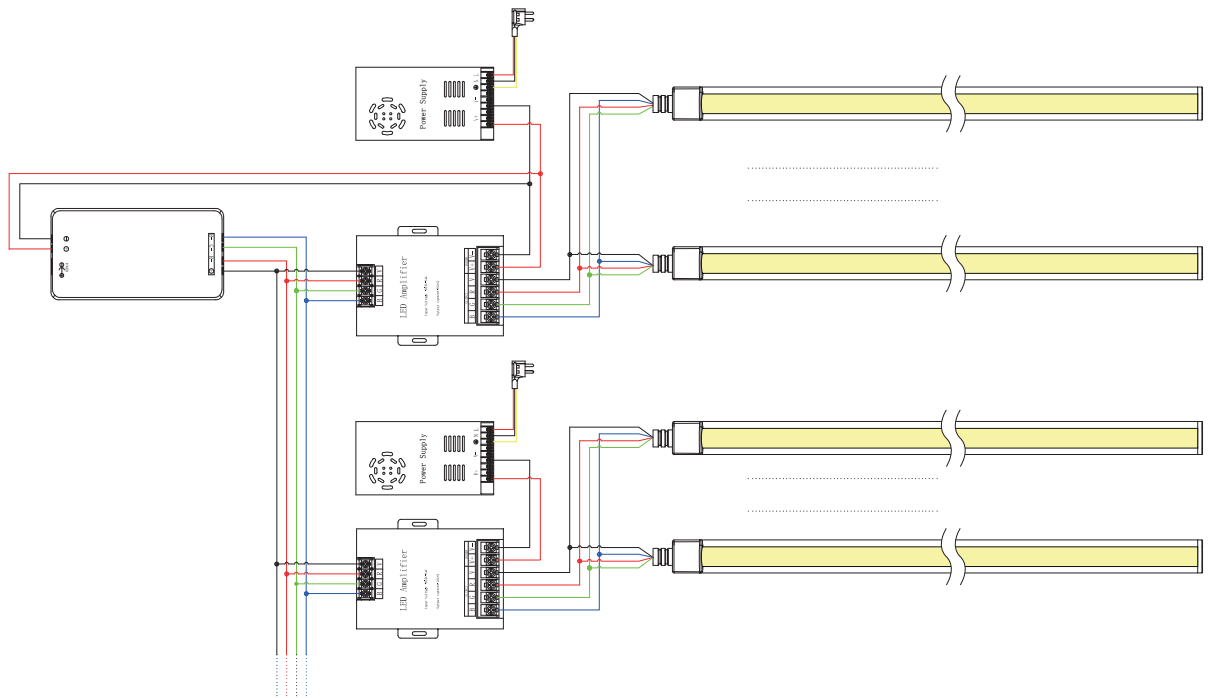

RGBW Connection Diagram

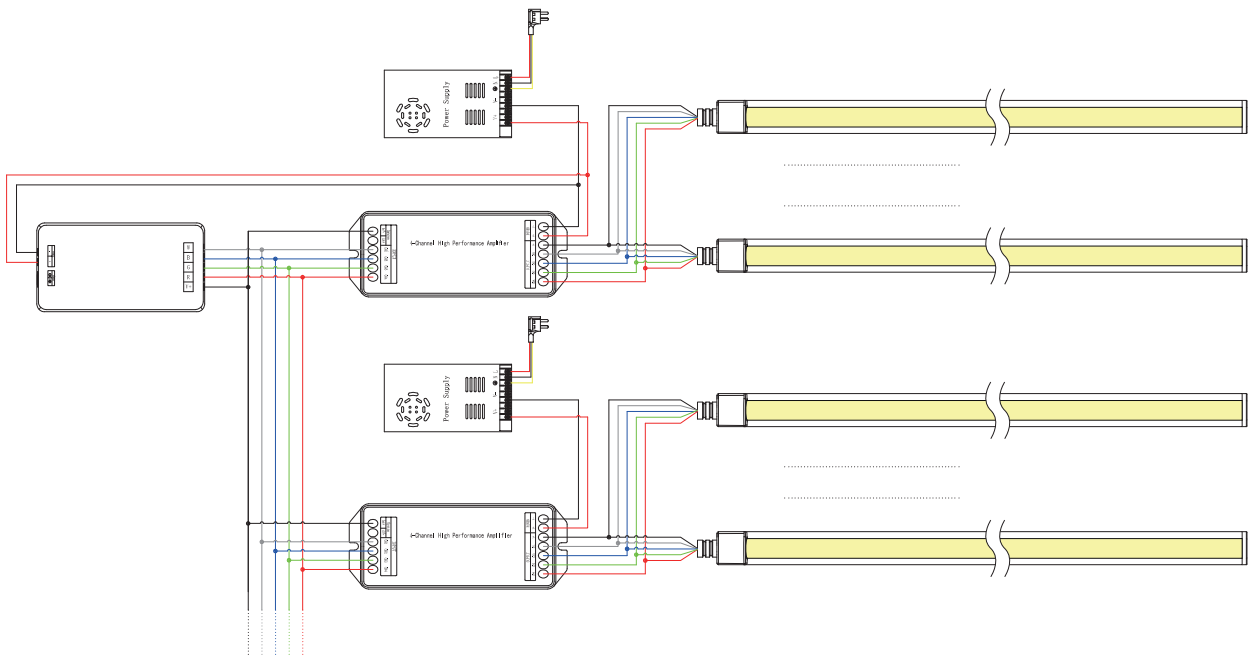

RGBWW Connection Diagram

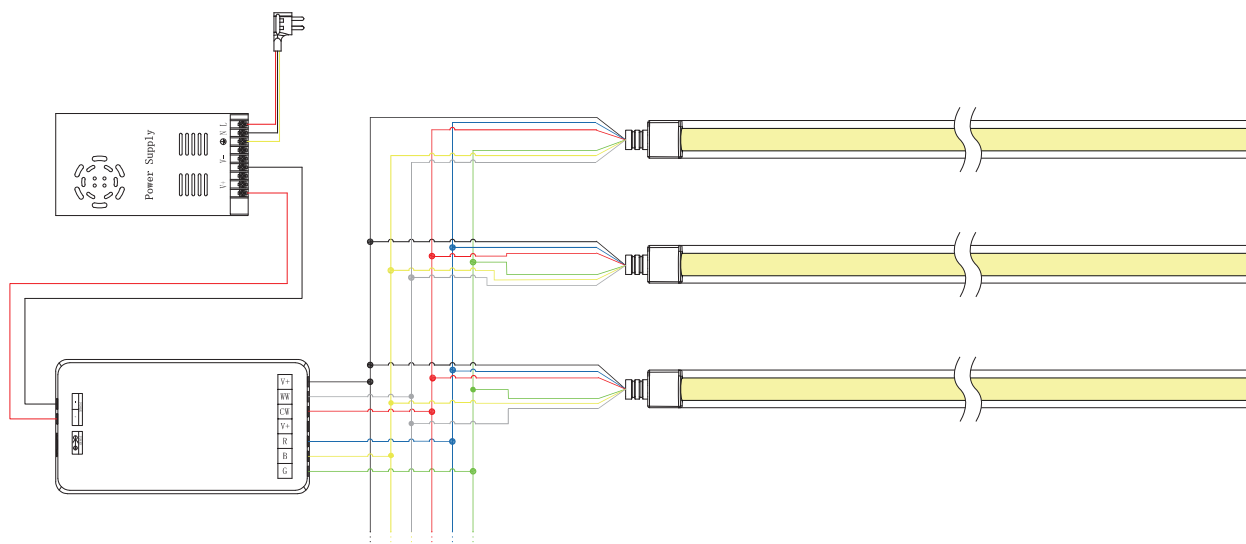

Digital RGB Connection Diagram

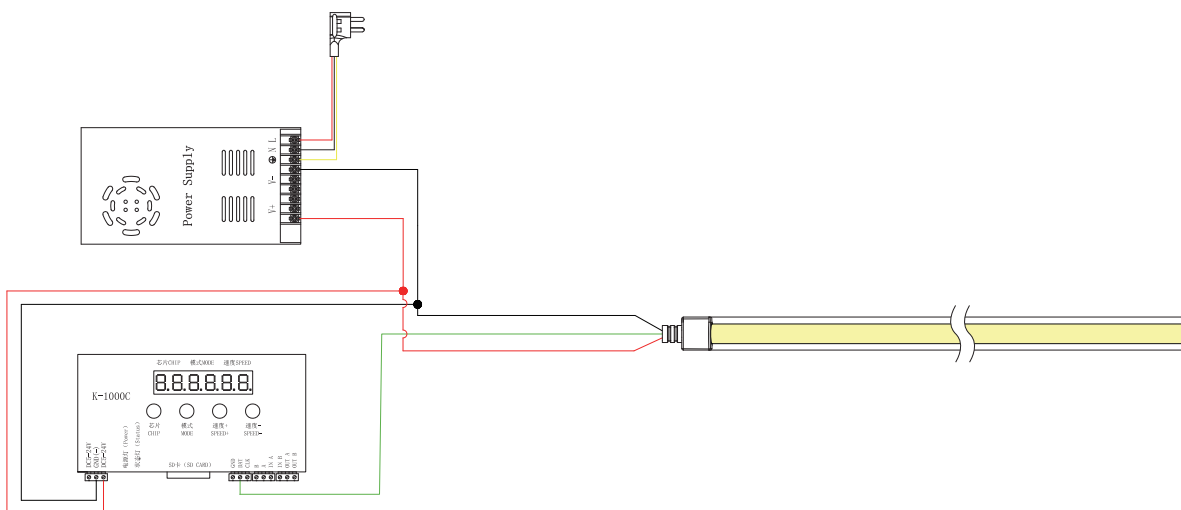

Installation Diagram

Installation with 3M tape

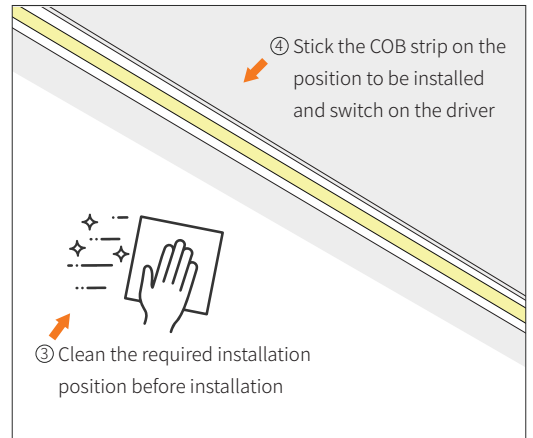
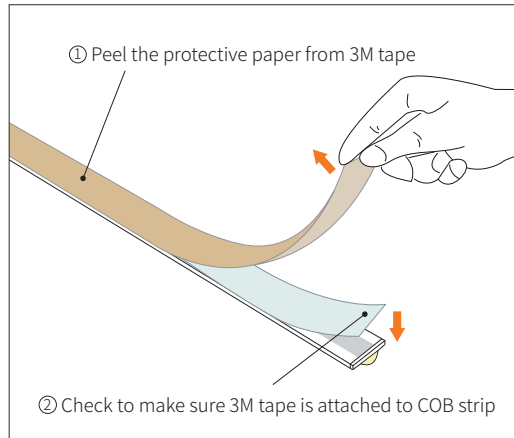

Installation with aluminum clips

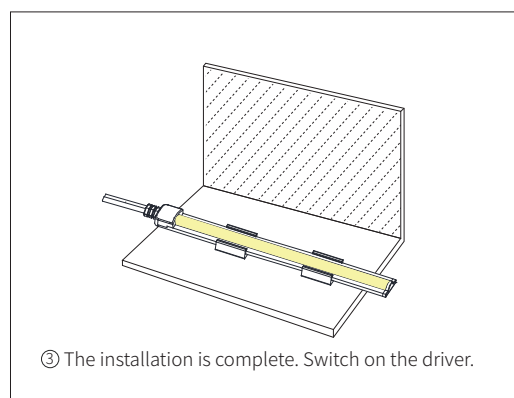
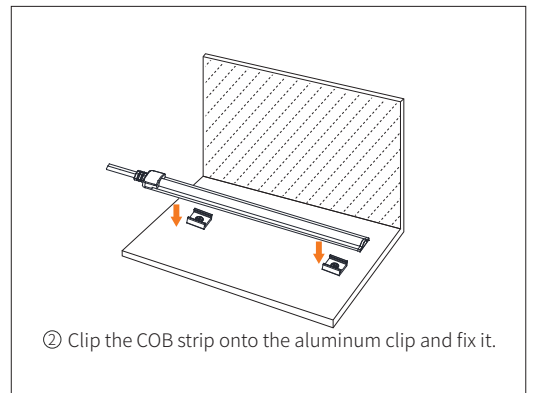
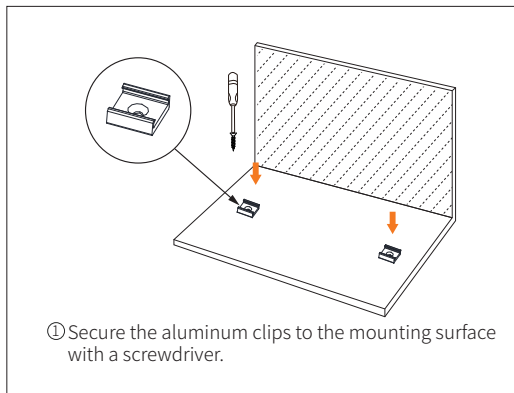

Cautions

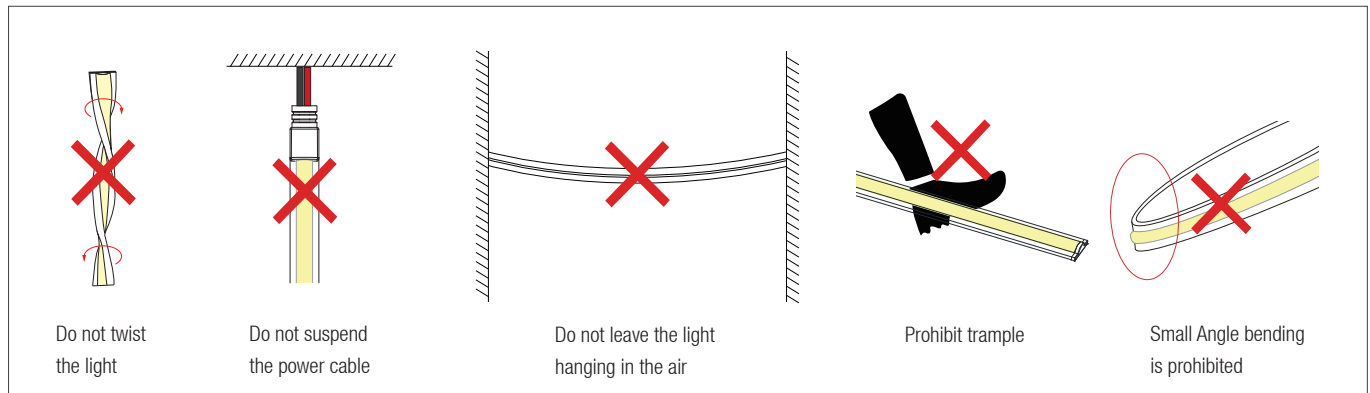

- ※ The unused light should be sealed with the packaging bag to avoid prolonged exposure.
- ※ Please use DC24V isolated constant voltage power supply with ripple voltage less than 5%. Using other types of power supply may damage the light or cause other safety risks.
- ※ In practical application, 20% allowance should be reserved for power supply to ensure the stability of power supply.
- ※ It is recommended that professionals connect the power supply. Do not connect the power supply with live power to avoid electric shock.
- ※ Please confirm whether the voltage of the power supply is consistent with the voltage of the light; Pay attention to the positive and negative poles of the power cord, do not connect wrong, so as not to cause product damage;
- ※ When multiple power supplies are used, ensure that the positive poles of the power supply are not connected in parallel. Otherwise, the power supply system may be unstable or damaged after long-term operation.
- ※ If the actual application length exceeds the specified length, it will lead to overload, heating and uneven brightness of the light.
- ※ During installation, please do not scratch, twist, or bend the light irregularly. Otherwise, the light may be damaged beyond repair.
- ※ To ensure the life and reliability of the light, please do not over bend the light, which will damage the product itself.
- ※ To protect your eyes, please avoid staring at the glowing surface of the light for a long time.
- ※ Non-professionals are forbidden to install, disassemble and maintain the product.
- ※ Do not use any acid or alkaline adhesive to fix the light (including but not limited to glass glue, etc.)
- ※ Products of different waterproof levels apply to different environments. For example, IP65 cannot be used underwater.
- ※ IP68 products are factory assembly only. If the user cut it, its waterproof grade will decline.
- ※ Because of the difference in structure, even if the same color temperature value, different sizes of light will look slightly different colors. Please confirm it before use.

Tests showed that methanol and benzenes will have yellowing effects on silicone.

In the newly decorated interior environment, epoxy floor paint, wall paint, wallpaper adhesive, various decoration materials or new furniture, they are likely to release of methanol and benzenes.

It is recommended to remove methanol and benzenes first, or ventilate for a period of time in the newly decorated interior environment before install the silicone neon light, to avoid affecting the silicone body.



Specialized LED strip Manufacturer

TYRIA LIGHTING TECHNOLOGY CO., LIMITED



F1: 2F, D Building, Antonio Technology Park, Ma'anshan Community, Shajing Street, Baoan District, Shenzhen, Guangdong, China

F2: Shancheng Industrial Zone, Shiyan Town, Baoan District, Shenzhen, Guangdong, China



OUR EMAIL

info@tyrialight.com



OUR PHONE

Tel: 0755-36931652



OUR WEBSITE

Web: www.tyrialight.com