

# SILICONE NEON STRIP

Breakpoint Transmission  
DMX512  
SPI

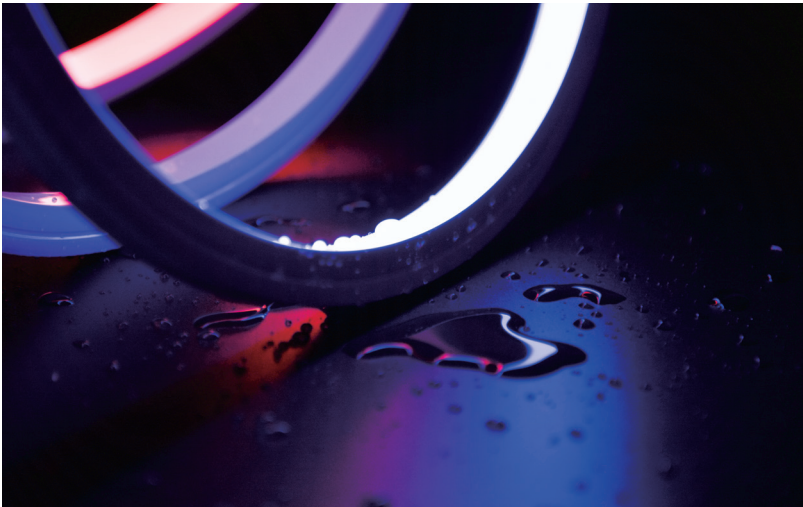

## SPI

Simple application, only need a single data cable can complete the transmission of data;

## Breakpoint Transmission

With dual data cable, the main data cable can be automatically switched to the standby data cable when the fault, enhance the reliability of data transmission;

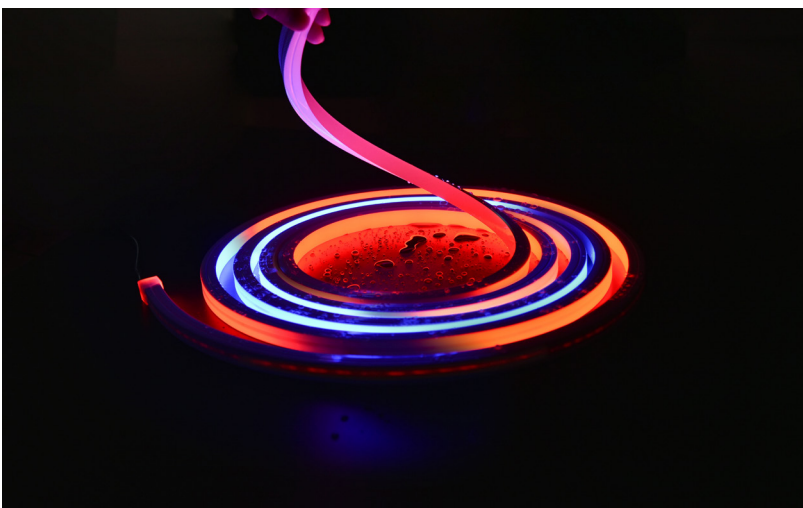

## DMX512

Compatible with international standard protocol DMX512 (1990).  
Adopting signal differential transmission mode, to ensure stronger anti-interference ability and longer transmission distance.

## Product List

Model	Voltage (V)	Power (W/M)	Lumen (LM/M)	Efficiency (LM/W)	Pixel (PCS)	Unit length (mm)	IC Model	Page
TY-NT1615V24P12-Crgb-WS2818	DC24V	12	262	21.8	8	125	UCS2603 WS2818	01
TY-NT1615V24P15-Crgbw-UCS2904	DC24V	14.5	342	23.6	8	125	UCS2904	
TY-NT1615V24P12-Crgb-DMX512	DC24V	12	266	22.2	8	125	UCS512C2L	
TY-NT1615V24P15-Crgbw-DMX512	DC24V	15	329	21.9	8	125	UCS512C2L	
TY-NS1220V24P12-Crgb-WS2818	DC24V	12	159	13.3	8	125	UCS2603 WS2818	03
TY-NS1220V24P15-Crgbw-UCS2904	DC24V	14.5	218	15.0	8	125	UCS2904	
TY-NS1220V24P12-Crgb-DMX512	DC24V	12	161	13.4	8	125	UCS512C2L	
TY-NS1220V24P15-Crgbw-DMX512	DC24V	15	211	14.1	8	125	UCS512C2L	
TY-NS1225V24P12-Crgb-WS2818	DC24V	12	145	12.1	8	125	UCS2603 WS2818	05
TY-NS1225V24P15-Crgbw-UCS2904	DC24V	14.5	200	13.8	8	125	UCS2904	
TY-NS1225V24P12-Crgb-DMX512	DC24V	12	148	12.3	8	125	UCS512C2L	
TY-NS1225V24P15-Crgbw-DMX512	DC24V	15	208	13.9	8	125	UCS512C2L	
TY-NS1212V24P13-Crgb-WS2811	DC24V	12.5	266	21.3	10	100	WS2811	07
TY-NS0612V24P13-Crgb-WS2811	DC24V	12.5	162	13.0	10	100	WS2811	08
TY-NS0817V24P13-Crgb-WS2811	DC24V	12.5	152	12.2	10	100	WS2811	09
TY-NT1010V24P13-Crgb-WS2811	DC24V	12.5	304	24.3	10	100	WS2811	10
TY-NTD16V24P13-Crgb-WS2811	DC24V	12.5	294	23.5	10	100	WS2811	11
TY-NS1612DV24P13-Crgb-WS2811	DC24V	12.5	266	21.3	10	100	WS2811	12
TY-NR25V24P25-Crgb-WS2811	DC24V	25	474	19	10	100	WS2811	13
TY-NS0817EV24P13-Crgb-WS2811	DC24V	12.5	177	14.2	10	100	WS2811	15
TY-NT1212EV24P13-Crgb-WS2811	DC24V	12.5	277	22.2	10	100	WS2811	16

Note: If there are multiple IC model options for a product in the selection table, it only means that the PCB can be compatible with the listed IC models, but it does not mean that the control protocols of the listed IC are the same. When the customer chooses the controller by himself, please check whether the controller supports the IC of the specified light strip.

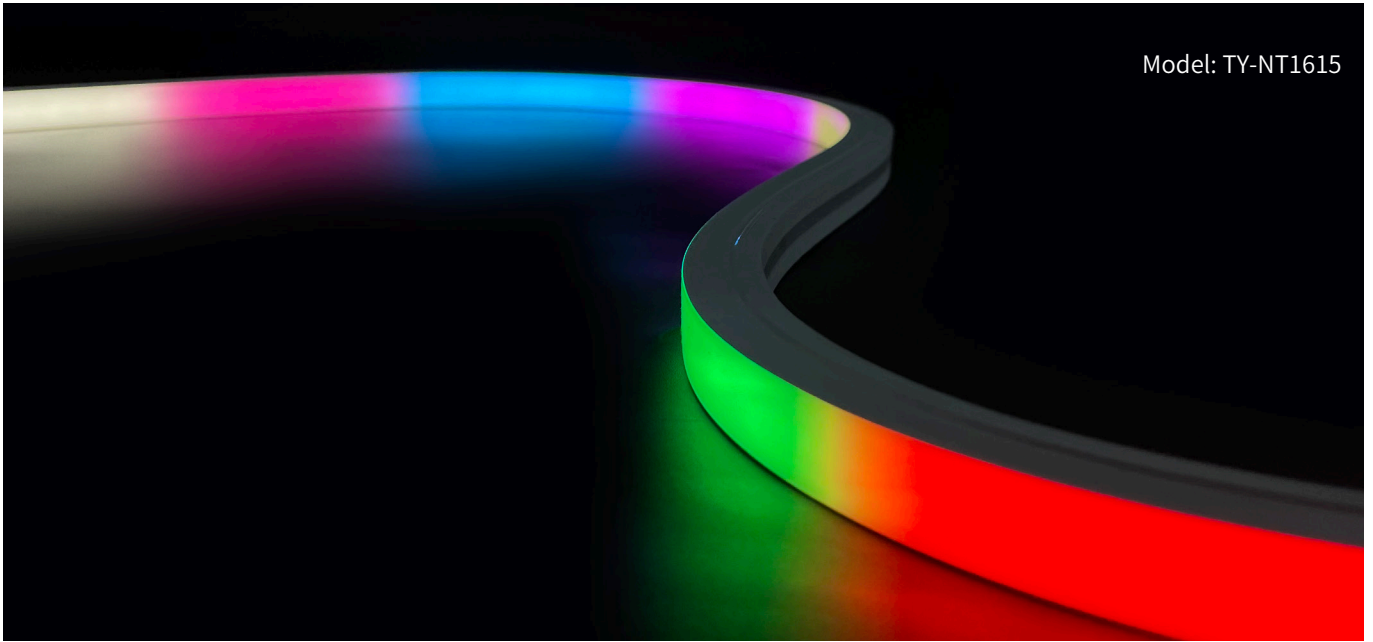

### Product Features

- It is made of Dow Chemical SILASTIC™ ET-7021 silicone rubber, which provides high transparency and high strength.
- Environmental protection grade silicone material, integrated extrusion molding process.
- Unique optical light distribution structure design, uniform lighting surface and no shadow.
- IP67 protection level, salt solution resistance, weak acid and alkali corrosion and UV.
- Excellent toughness, simple and stylish appearance, delicate and unique.
- 3 years warranty, working life  $\geq 30000$  hours;



Voltage  
**24v DC**



IP Level  
**IP 67**



UV  
**Protection**





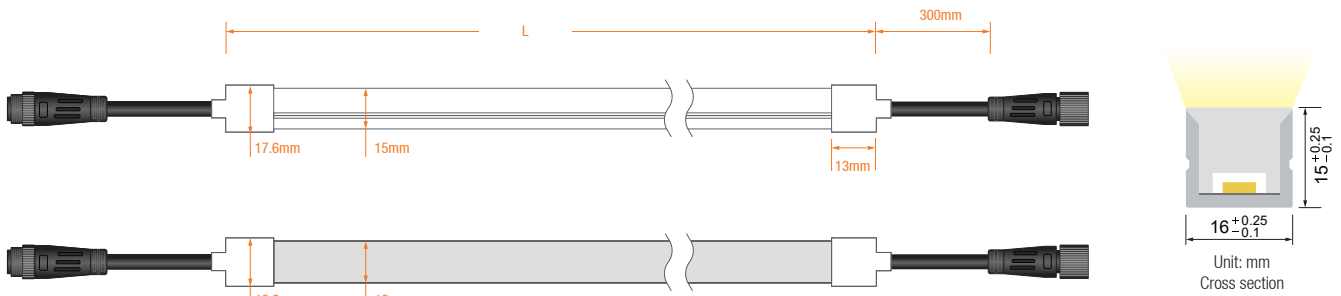

Warranty  
**3 Years**

### Dimension structure



### Cable

Cable Type	Schematic Diagram	Specification	Core	Electrical Properties
PVC Cable		OD: 5.0mm	● ● ●	SPI: Red V+, Green DI/DO, Black V-
		OD: 5.5mm	● ● ● ●	Breakpoint Transmission: RedV+, GreenBI/BO, BlueDI/DO, BlackV-
		OD: 5.5mm	● ● ● ● ○ ●	DMX512: RedV+, GreenPI/PO, BlueAI/AO, WhiteBI/BO, BlackV-
Silicone Cable		OD: 5.0mm	● ● ●	SPI: RedV+, GreenDI/DO, BlackV-
		OD: 6.0mm	● ● ● ●	Breakpoint Transmission: RedV+, GreenBI/BO, BlueDI/DO, BlackV-
		OD: 6.0mm	● ● ● ● ○ ●	DMX512: RedV+, GreenPI/PO, BlueAI/AO, WhiteBI/BO, BlackV-



**RGB** (TY-NT1615V24P12-Crgb-WS2818)

Voltage (V)	Power (W/M)	CCT/Color	Lumen (LM/M)	Efficiency (LM/W)	Pixel (PCS)	Unit length (mm)	Signal Type	IC Model
DC24V	5	R	48	9.6	8	125	Breakpoint Transmission	UCS2603/WS2818
	5	G	184	36.8				
	5	B	32	6.4				
	12	RGB	262	21.8				

**RGBW** (TY-NT1615V24P15-Crgbw-UCS2904)

Voltage (V)	Power (W/M)	CCT/Color	Lumen (LM/M)	Efficiency (LM/W)	Pixel (PCS)	Unit length (mm)	Signal Type	IC Model
DC24V	4.8	R	42	8.8	8	125	SPI	UCS2904
	4.8	G	117	24.4				
	4.8	B	36	7.5				
	4.8	W(4000K)	162	33.8				
	14.5	RGBW	342	23.6				

**RGB** (TY-NT1615V24P12-Crgb-DMX512)

Voltage (V)	Power (W/M)	CCT/Color	Lumen (LM/M)	Efficiency (LM/W)	Pixel (PCS)	Unit length (mm)	Signal Type	IC Model
DC24V	4.8	R	51	10.6	8	125	DMX512	UCS512C2L
	4.8	G	191	39.8				
	4.8	B	32	6.7				
	12	RGB	266	22.2				

**RGBW** (TY-NT1615V24P15-Crgbw-DMX512)

Voltage (V)	Power (W/M)	CCT/Color	Lumen (LM/M)	Efficiency (LM/W)	Pixel (PCS)	Unit length (mm)	Signal Type	IC Model
DC24V	4.8	R	44	9.2	8	125	DMX512	UCS512C2L
	4.8	G	119	24.8				
	4.8	B	34	7.1				
	4.8	W(4000K)	153	31.9				
	15	RGBW	329	21.9				

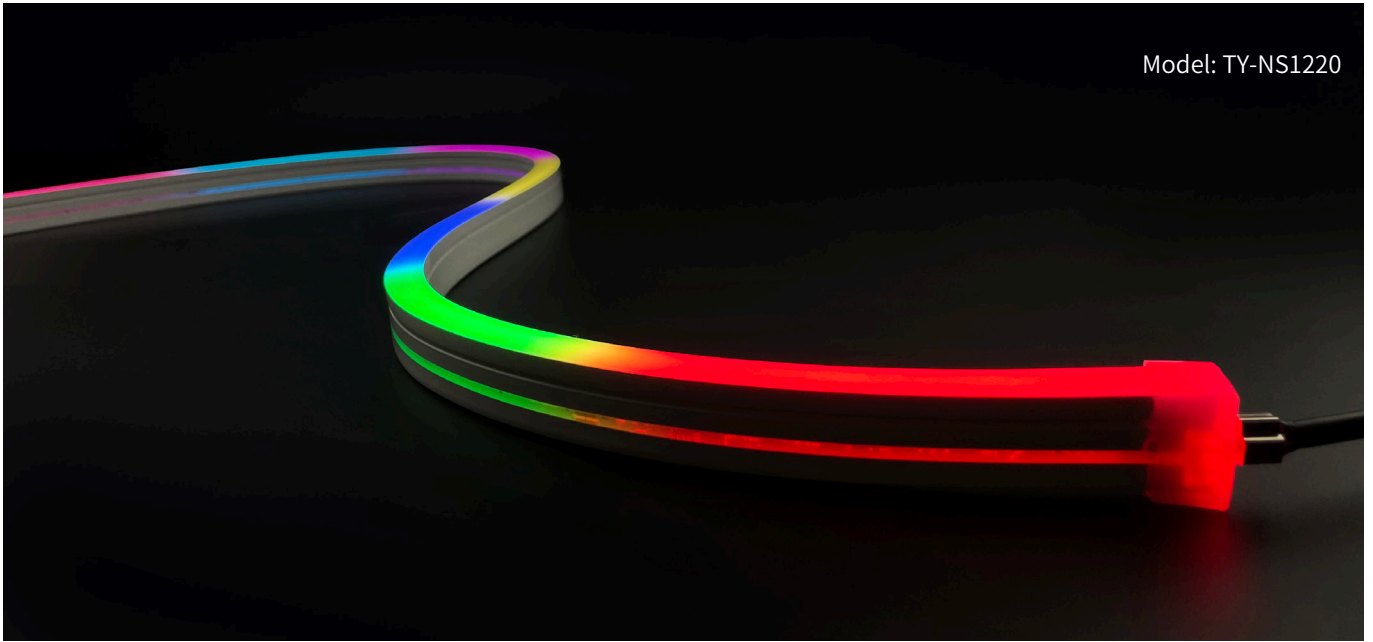

### Product Features

- It is made of Dow Chemical SILASTIC™ ET-7021 silicone rubber, which provides high transparency and high strength.
- Environmental protection grade silicone material, integrated extrusion molding process.
- Unique optical light distribution structure design, uniform lighting surface and no shadow.
- IP67 protection level, salt solution resistance, weak acid and alkali corrosion and UV.
- Excellent toughness, simple and stylish appearance, delicate and unique.
- 3 years warranty, working life  $\geq 30000$  hours;



Voltage  
**24v DC**



IP Level  
**IP 67**



UV  
**Protection**



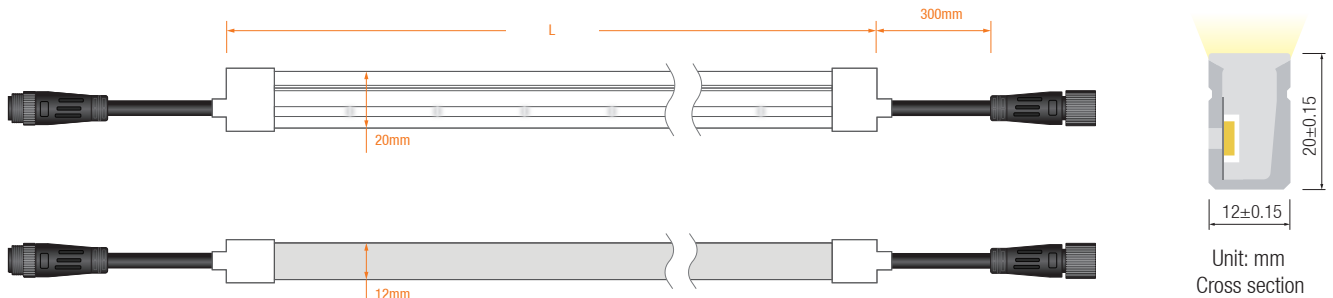

Warranty  
**3 Years**

### Dimension structure



### Cable

Cable Type	Schematic Diagram	Specification	Core	Electrical Properties
PVC Cable		OD: 5.0mm	● ● ●	SPI: Red V+, Green DI/DO, Black V-
		OD: 5.5mm	● ● ● ●	Breakpoint Transmission: RedV+, GreenBI/BO, BlueDI/DO, BlackV-
		OD: 5.5mm	● ● ● ● ●	DMX512: RedV+, GreenPI/PO, BlueAI/AO, WhiteBI/BO, BlackV-
Silicone Cable		OD: 5.0mm	● ● ●	SPI: RedV+, GreenDI/DO, BlackV-
		OD: 6.0mm	● ● ● ●	Breakpoint Transmission: RedV+, GreenBI/BO, BlueDI/DO, BlackV-
		OD: 6.0mm	● ● ● ● ●	DMX512: RedV+, GreenPI/PO, BlueAI/AO, WhiteBI/BO, BlackV-

**RGB** (TY-NS1220V24P12-Crgb-WS2818)

Voltage (V)	Power (W/M)	CCT/Color	Lumen (LM/M)	Efficiency (LM/W)	Pixel (PCS)	Unit length (mm)	Signal Type	IC Model
DC24V	5	R	28	5.6	8	125	Breakpoint Transmission	UCS2603/WS2818
	5	G	110	22.1				
	5	B	20	4.0				
	12	RGB	159	13.2				

**RGBW** (TY-NS1220V24P15-Crgbw-UCS2904)

Voltage (V)	Power (W/M)	CCT/Color	Lumen (LM/M)	Efficiency (LM/W)	Pixel (PCS)	Unit length (mm)	Signal Type	IC Model
DC24V	4.8	R	29	6.0	8	125	SPI	UCS2904
	4.8	G	78	16.3				
	4.8	B	23	4.8				
	4.8	W(4000K)	96	20.0				
	14.5	RGBW	218	15.0				

**RGB** (TY-NS1220V24P12-Crgb-DMX512)

Voltage (V)	Power (W/M)	CCT/Color	Lumen (LM/M)	Efficiency (LM/W)	Pixel (PCS)	Unit length (mm)	Signal Type	IC Model
DC24V	4.8	R	30	6.3	8	125	DMX512	UCS512C2L
	4.8	G	115	24.0				
	4.8	B	20	4.2				
	12	RGB	161	13.4				

**RGBW** (TY-NS1220V24P15-Crgbw-DMX512)

Voltage (V)	Power (W/M)	CCT/Color	Lumen (LM/M)	Efficiency (LM/W)	Pixel (PCS)	Unit length (mm)	Signal Type	IC Model
DC24V	4.8	R	28	5.8	8	125	DMX512	UCS512C2L
	4.8	G	80	16.7				
	4.8	B	16	3.3				
	4.8	W(4000K)	96	20.0				
	15	RGBW	211	14.1				

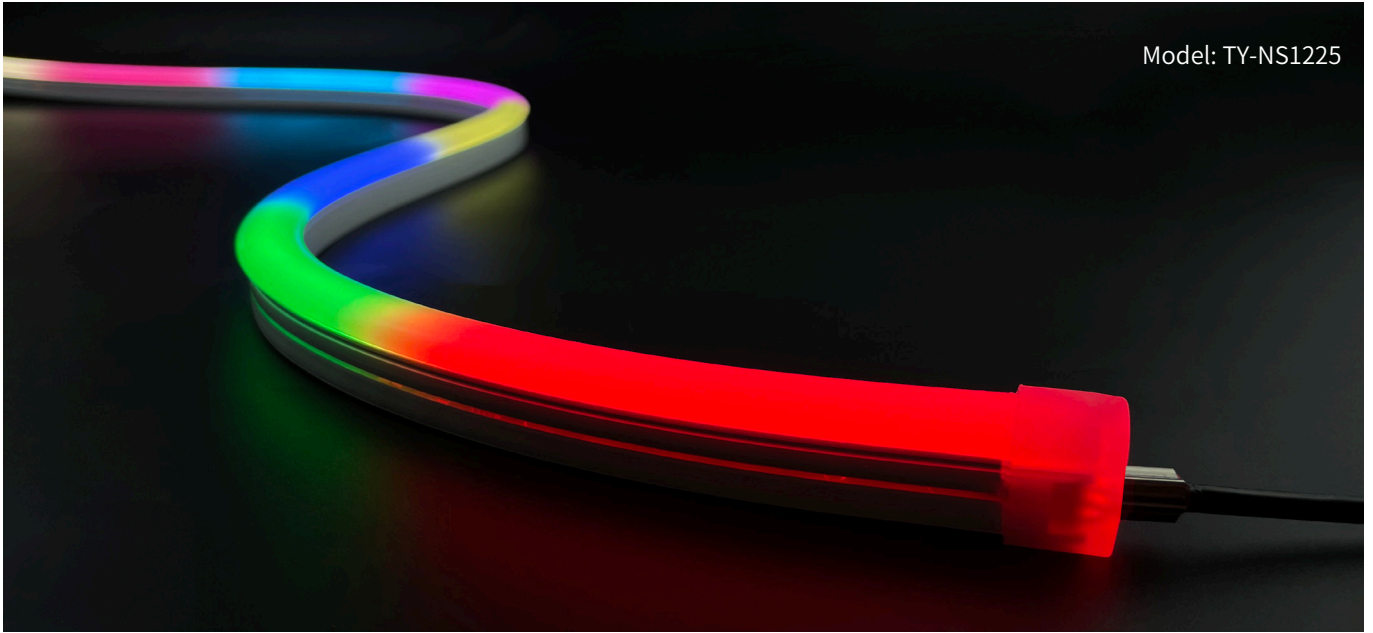

### Product Features

- It is made of Dow Chemical SILASTIC™ ET-7021 silicone rubber, which provides high transparency and high strength.
- Environmental protection grade silicone material, integrated extrusion molding process.
- Unique optical light distribution structure design, uniform lighting surface and no shadow.
- IP67 protection level, salt solution resistance, weak acid and alkali corrosion and UV.
- Excellent toughness, simple and stylish appearance, delicate and unique.
- 3 years warranty, working life  $\geq 30000$  hours;



Voltage  
**24v DC**



IP Level  
**IP 67**



UV  
**Protection**





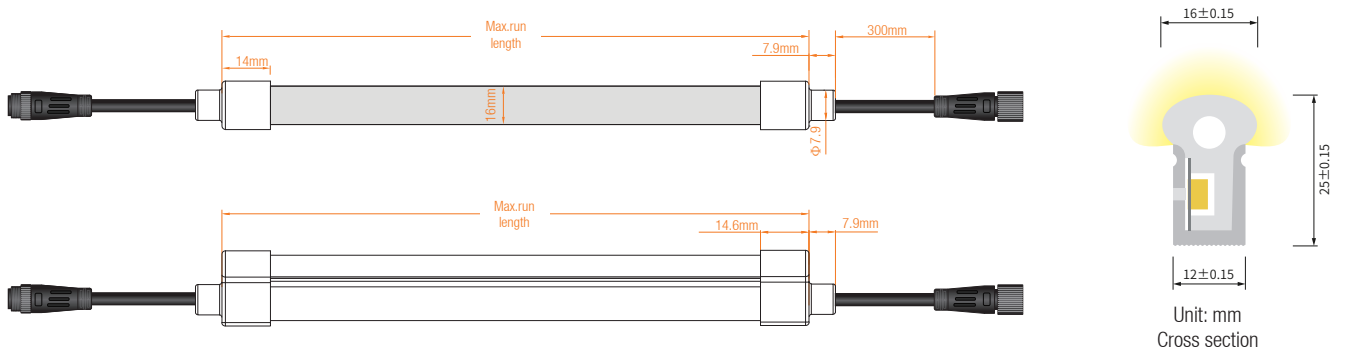

Warranty  
**3 Years**

### Dimension structure



### Cable

Cable Type	Schematic Diagram	Specification	Core	Electrical Properties
PVC Cable		OD: 5.0mm	● ● ●	SPI: Red V+, Green DI/DO, Black V-
		OD: 5.5mm	● ● ● ●	Breakpoint Transmission: RedV+, GreenBI/BO, BlueDI/DO, BlackV-
		OD: 5.5mm	● ● ● ● ●	DMX512: RedV+, GreenPI/PO, BlueAI/AO, WhiteBI/BO, BlackV-
Silicone Cable		OD: 5.0mm	● ● ●	SPI: RedV+, GreenDI/DO, BlackV-
		OD: 6.0mm	● ● ● ●	Breakpoint Transmission: RedV+, GreenBI/BO, BlueDI/DO, BlackV-
		OD: 6.0mm	● ● ● ● ●	DMX512: RedV+, GreenPI/PO, BlueAI/AO, WhiteBI/BO, BlackV-

**RGB** (TY-NS1225V24P12-Crgb-WS2818)

Voltage (V)	Power (W/M)	CCT/Color	Lumen (LM/M)	Efficiency (LM/W)	Pixel (PCS)	Unit length (mm)	Signal Type	IC Model
DC24V	5	R	25	5.0	8	125	Breakpoint Transmission	UCS2603/WS2818
	5	G	102	20.4				
	5	B	19	3.8				
	12	RGB	145	12.1				

**RGBW** (TY-NS1225V24P15-Crgbw-UCS2904)

Voltage (V)	Power (W/M)	CCT/Color	Lumen (LM/M)	Efficiency (LM/W)	Pixel (PCS)	Unit length (mm)	Signal Type	IC Model
DC24V	4.8	R	24	5.0	8	125	SPI	UCS2904
	4.8	G	72	15.0				
	4.8	B	22	4.6				
	4.8	W(4000K)	87	18.1				
	14.5	RGBW	200	13.8				

**RGB** (TY-NS1225V24P12-Crgb-DXM512)

Voltage (V)	Power (W/M)	CCT/Color	Lumen (LM/M)	Efficiency (LM/W)	Pixel (PCS)	Unit length (mm)	Signal Type	IC Model
DC24V	4.8	R	27	5.6	8	125	DMX512	UCS512C2L
	4.8	G	107	22.3				
	4.8	B	19	4.0				
	12	RGB	148	12.3				

**RGBW** (TY-NS1225V24P15-Crgbw-DXM512)

Voltage (V)	Power (W/M)	CCT/Color	Lumen (LM/M)	Efficiency (LM/W)	Pixel (PCS)	Unit length (mm)	Signal Type	IC Model
DC24V	4.8	R	26	5.4	8	125	DMX512	UCS512C2L
	4.8	G	74	15.4				
	4.8	B	23	4.8				
	4.8	W(4000K)	90	18.8				
	15	RGBW	208	13.9				

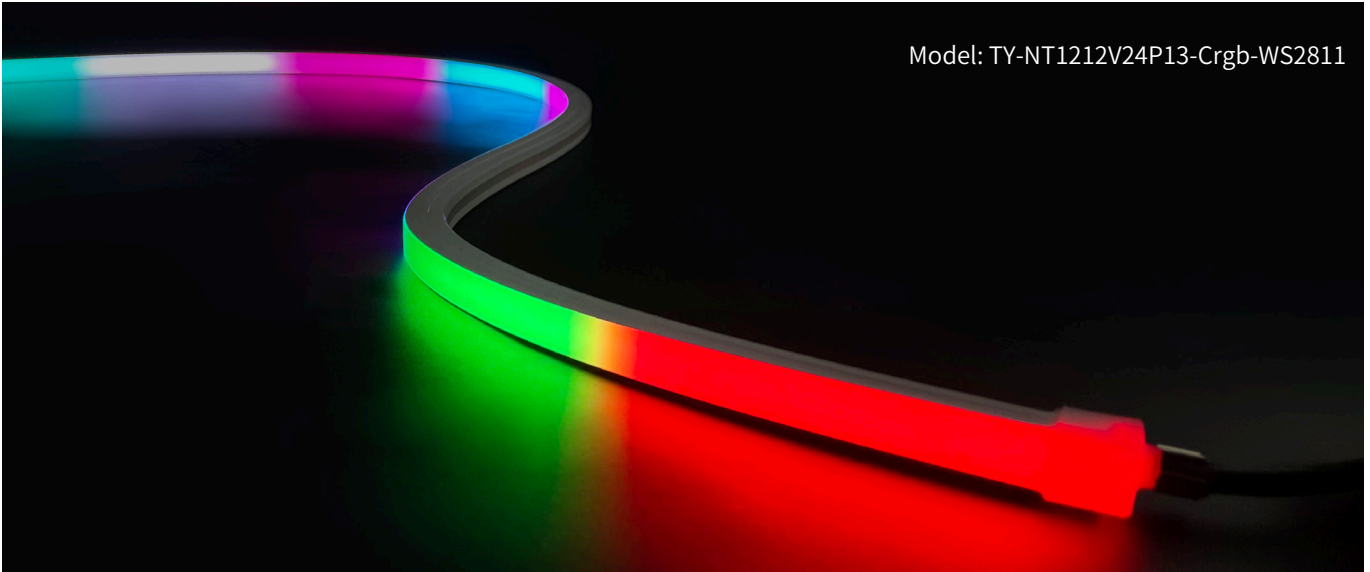

**Product Features**

- It is made of Dow Chemical SILASTIC™ ET-7021 silicone rubber, which provides high transparency and high strength.
- Environmental protection grade silicone material, integrated extrusion molding process.
- Unique optical light distribution structure design, uniform lighting surface and no shadow.
- IP67 protection level, salt solution resistance, weak acid and alkali corrosion and UV.
- Excellent toughness, simple and stylish appearance, delicate and unique.
- 3 years warranty, working life ≥ 30000 hours;

Voltage  
24v DC

IP Level  
IP 67

UV  
Protection

Warranty  
3 Years

**Dimension structure**

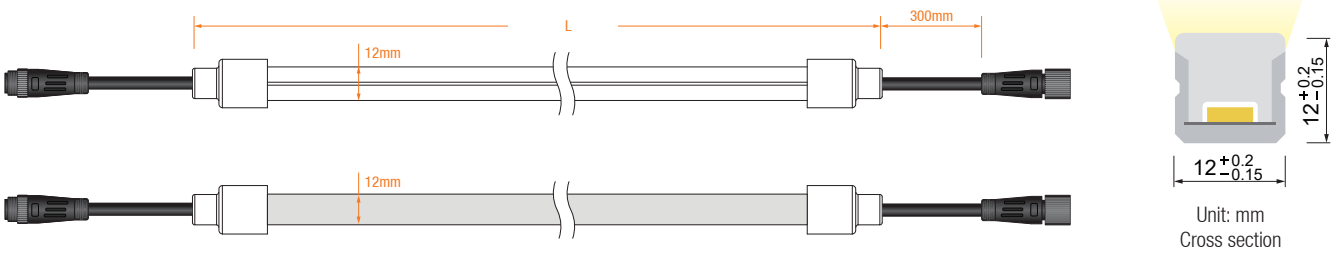

**Cable**

Cable Type	Schematic Diagram	Specification	Core	Electrical Properties
PVC Cable		OD: 5.0mm	<span style="color: red;">●</span> <span style="color: green;">●</span> <span style="color: black;">●</span>	SPI: Red V+, Green DI/DO, Black V-

**RGB**

Voltage (V)	Power (W/M)	CCT/Color	Lumen (LM/M)	Efficiency (LM/W)	Pixel (PCS)	Unit length (mm)	Signal Type	IC Model
DC24V	4.8	R	60	12.5	10	100	SPI	WS2811
	4.8	G	194	40.4				
	4.8	B	33	6.9				
	12.5	RGB	266	21.3				



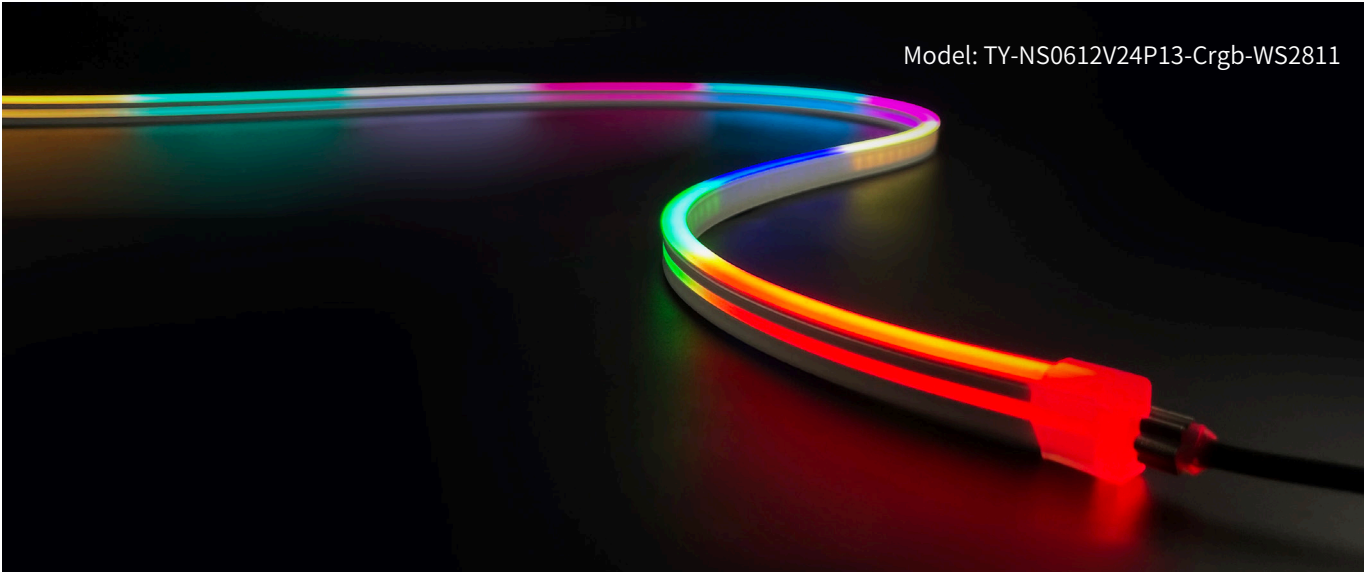

### Product Features

- It is made of Dow Chemical SILASTIC™ ET-7021 silicone rubber, which provides high transparency and high strength.
- Environmental protection grade silicone material, integrated extrusion molding process.
- Unique optical light distribution structure design, uniform lighting surface and no shadow.
- IP67 protection level, salt solution resistance, weak acid and alkali corrosion and UV.
- Excellent toughness, simple and stylish appearance, delicate and unique.
- 3 years warranty, working life  $\geq 30000$  hours;

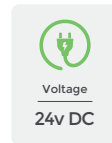

### Dimension structure

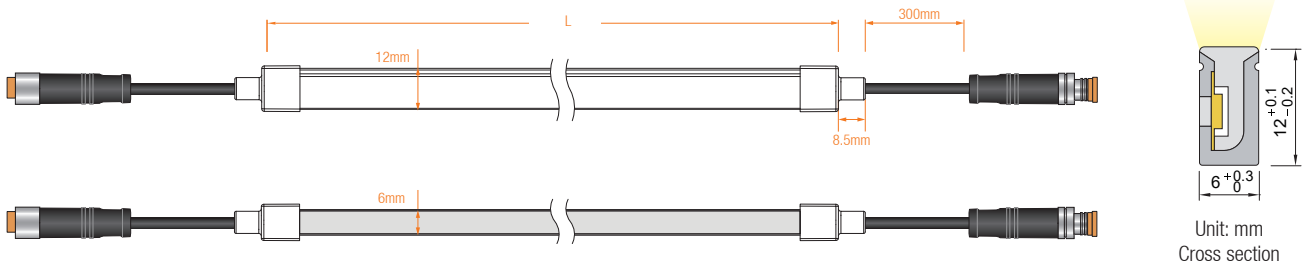

### Cable

Cable Type	Schematic Diagram	Specification	Core	Electrical Properties
PVC Cable		OD: 4.0mm	<span style="color: red;">●</span> <span style="color: green;">●</span> <span style="color: black;">●</span>	SPI: Red V+, Green DI/DO, Black V-

### RGB

Voltage (V)	Power (W/M)	CCT/Color	Lumen (LM/M)	Efficiency (LM/W)	Pixel (PCS)	Unit length (mm)	Signal Type	IC Model
DC24V	4.8	R	42	8.8	10	100	SPI	WS2811
	4.8	G	122	25.4				
	4.8	B	22	4.6				
	12.5	RGB	162	13.0				

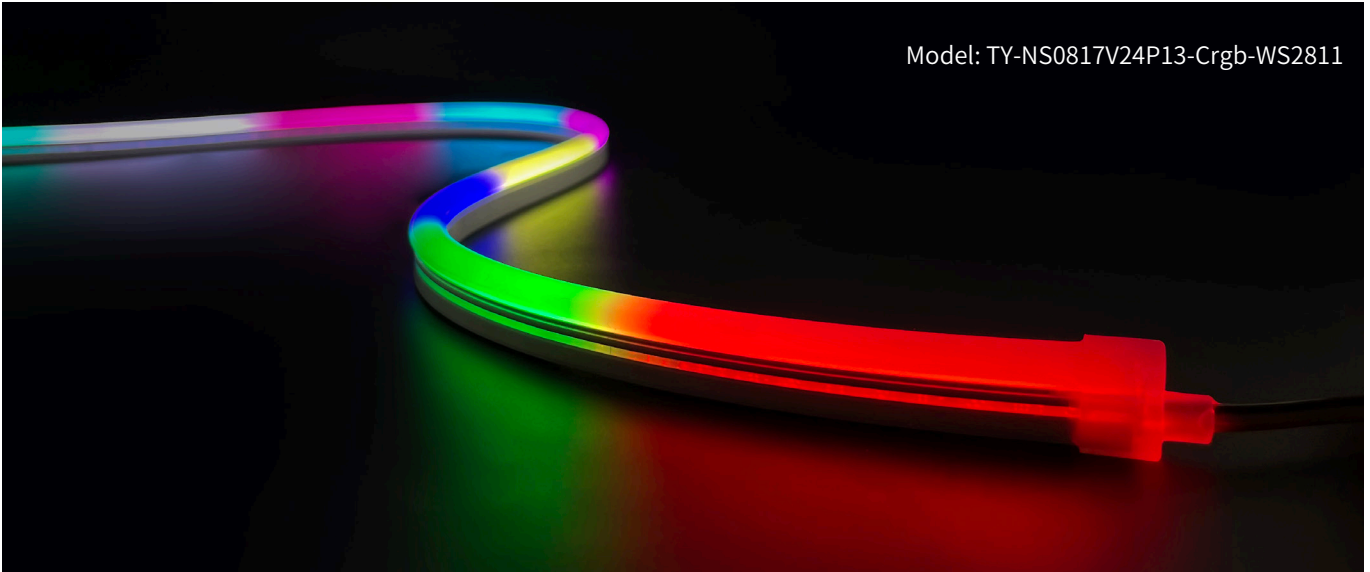

### Product Features

- It is made of Dow Chemical SILASTIC™ ET-7021 silicone rubber, which provides high transparency and high strength.
- Environmental protection grade silicone material, integrated extrusion molding process.
- Unique optical light distribution structure design, uniform lighting surface and no shadow.
- IP67 protection level, salt solution resistance, weak acid and alkali corrosion and UV.
- Excellent toughness, simple and stylish appearance, delicate and unique.
- 3 years warranty, working life  $\geq 30000$  hours;

Voltage  
24v DC

IP Level  
IP 67

UV  
Protection

Warranty  
3 Years

### Dimension structure

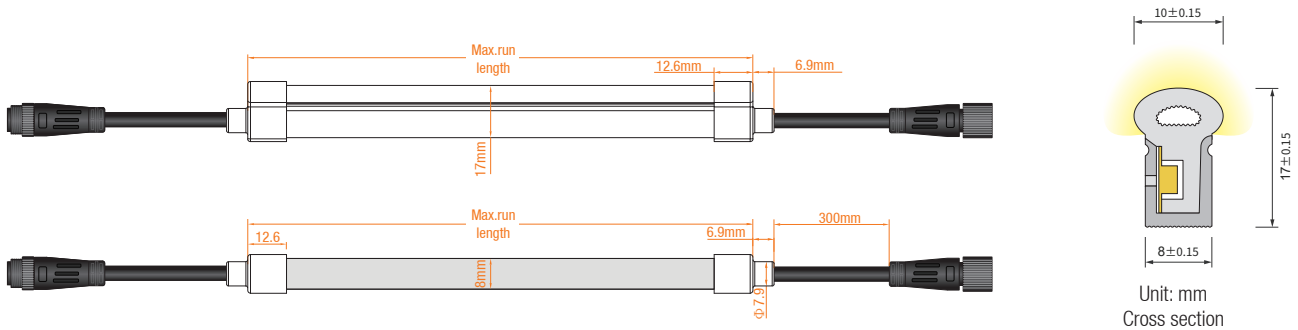

### Cable

Cable Type	Schematic Diagram	Specification	Core	Electrical Properties
PVC Cable		OD: 5.0mm	<span style="color: red;">●</span> <span style="color: green;">●</span> <span style="color: black;">●</span>	SPI: Red V+, Green DI/DO, Black V-

### RGB

Voltage (V)	Power (W/M)	CCT/Color	Lumen (LM/M)	Efficiency (LM/W)	Pixel (PCS)	Unit length (mm)	Signal Type	IC Model
DC24V	4.8	R	36	7.5	10	100	SPI	WS2811
	4.8	G	114	23.8				
	4.8	B	19	4.0				
	12.5	RGB	152	12.2				

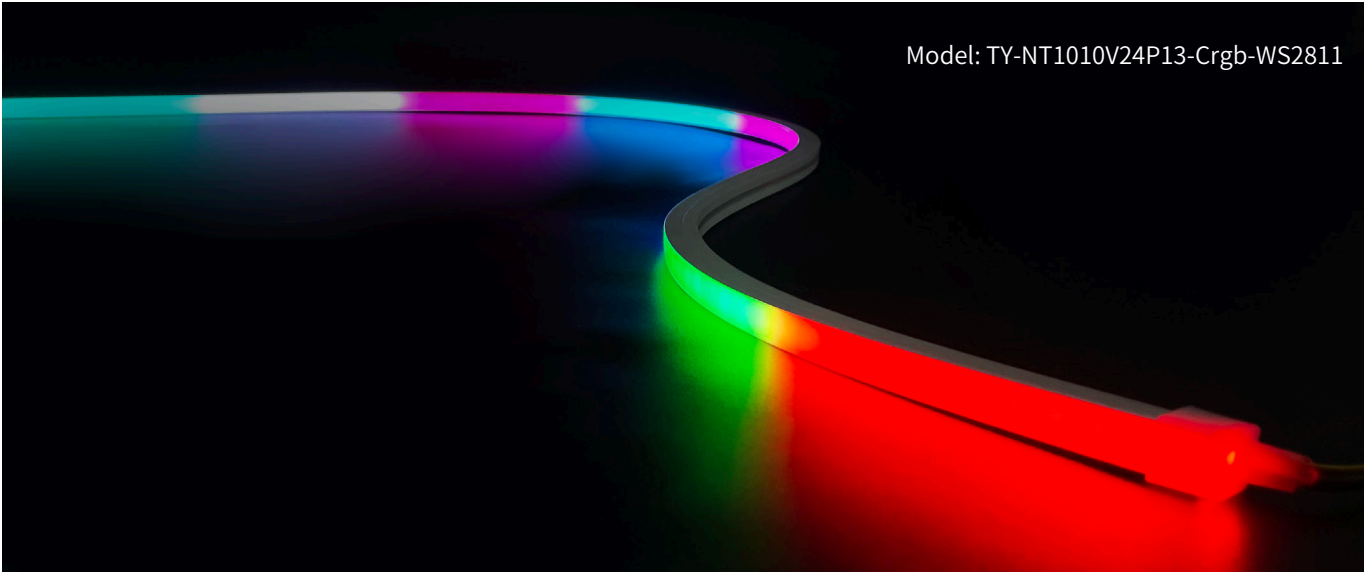

### Product Features

- It is made of Dow Chemical SILASTIC™ ET-7021 silicone rubber, which provides high transparency and high strength.
- Environmental protection grade silicone material, integrated extrusion molding process.
- Unique optical light distribution structure design, uniform lighting surface and no shadow.
- IP67 protection level, salt solution resistance, weak acid and alkali corrosion and UV.
- Excellent toughness, simple and stylish appearance, delicate and unique.
- 3 years warranty, working life  $\geq 30000$  hours;



Voltage  
24v DC



IP Level  
IP 67



UV  
Protection



Warranty  
3 Years

### Dimension structure

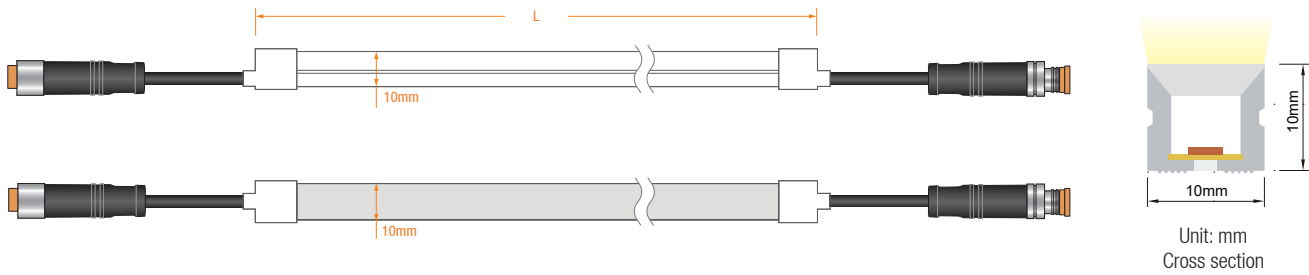

### Cable

Cable Type	Schematic Diagram	Specification	Core	Electrical Properties
PVC Cable		OD: 4.0mm	<span style="color: red;">●</span> <span style="color: green;">●</span> <span style="color: black;">●</span>	SPI: Red V+, Green DI/DO, Black V-

### RGB

Voltage (V)	Power (W/M)	CCT/Color	Lumen (LM/M)	Efficiency (LM/W)	Pixel (PCS)	Unit length (mm)	Signal Type	IC Model
DC24V	4.8	R	69	14.4	10	100	SPI	WS2811
	4.8	G	216	45.0				
	4.8	B	35	7.3				
	12.5	RGB	304	24.3				

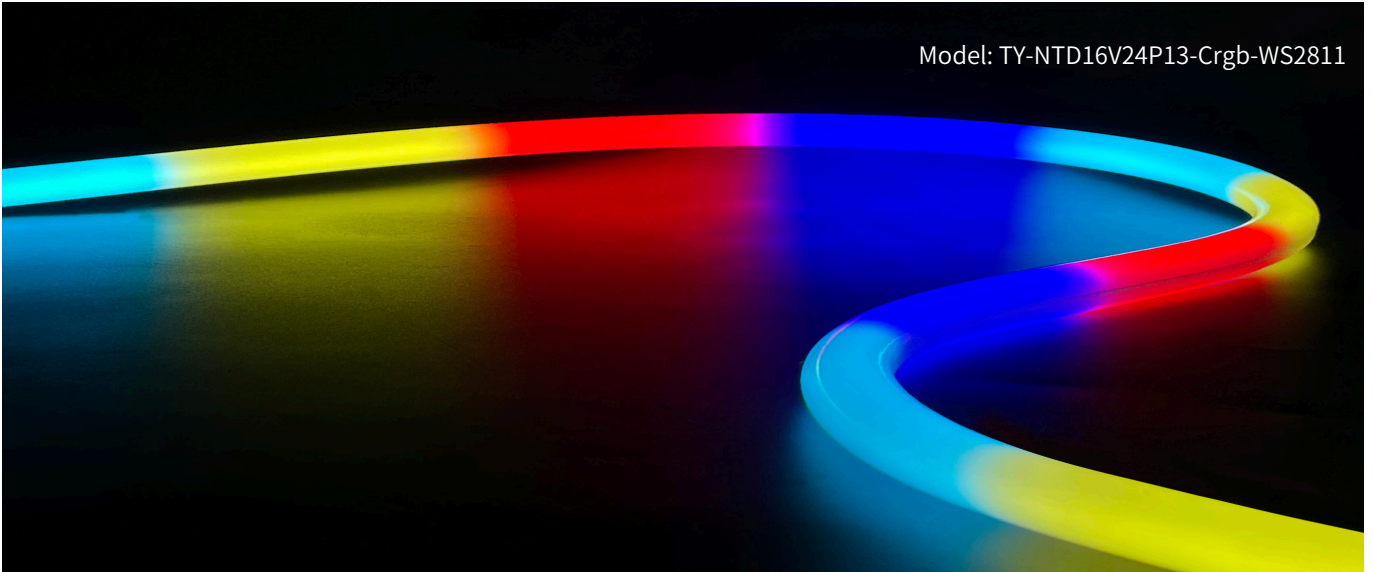

### Product Features

- It is made of Dow Chemical SILASTIC™ ET-7021 silicone rubber, which provides high transparency and high strength.
- Environmental protection grade silicone material, integrated extrusion molding process.
- Unique optical light distribution structure design, uniform lighting surface and no shadow.
- IP67 protection level, salt solution resistance, weak acid and alkali corrosion and UV.
- Excellent toughness, simple and stylish appearance, delicate and unique.
- 3 years warranty, working life  $\geq 30000$  hours;

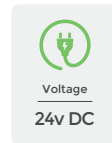

### Dimension structure

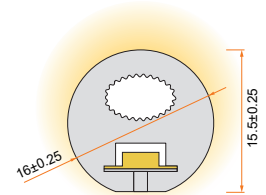
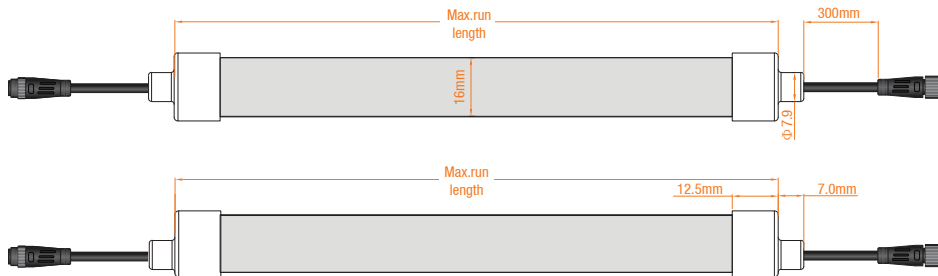

Unit: mm  
Cross section

### Cable

Cable Type	Schematic Diagram	Specification	Core	Electrical Properties
PVC Cable		OD: 5.0mm	<span style="color:red">●</span> <span style="color:green">●</span> <span style="color:black">●</span>	SPI: Red V+, Green DI/DO, Black V-

### RGB

Voltage (V)	Power (W/M)	CCT/Color	Lumen (LM/M)	Efficiency (LM/W)	Pixel (PCS)	Unit length (mm)	Signal Type	IC Model
DC24V	4.8	R	69	14.4	10	100	SPI	WS2811
	4.8	G	219	45.6				
	4.8	B	41	8.5				
	12.5	RGB	294	23.5				

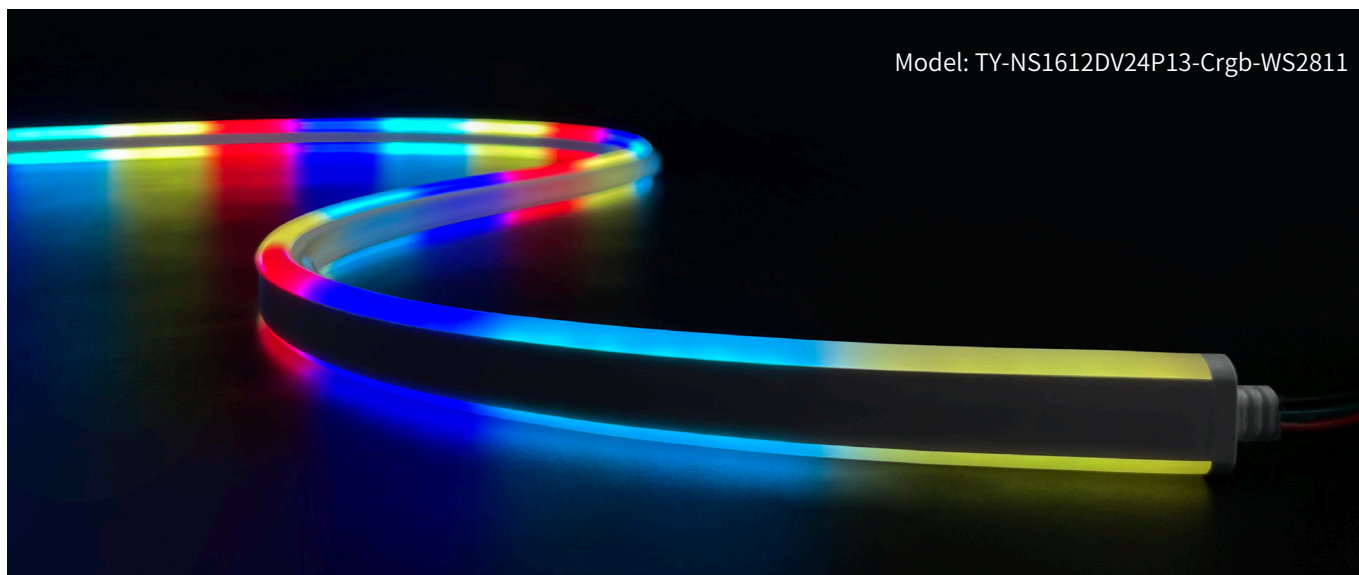

### Product Features

- It is made of Dow Chemical SILASTIC™ ET-7021 silicone rubber, which provides high transparency and high strength.
- Environmental protection grade silicone material, integrated extrusion molding process.
- Unique optical light distribution structure design, uniform lighting surface and no shadow.
- IP65 protection level, salt solution resistance, weak acid and alkali corrosion and UV.
- Excellent toughness, simple and stylish appearance, delicate and unique.
- 3 years warranty, working life  $\geq$  30000 hours;

Voltage  
24v DC

IP Level  
IP 65

UV  
Protection

Warranty  
3 Years

### Dimension structure

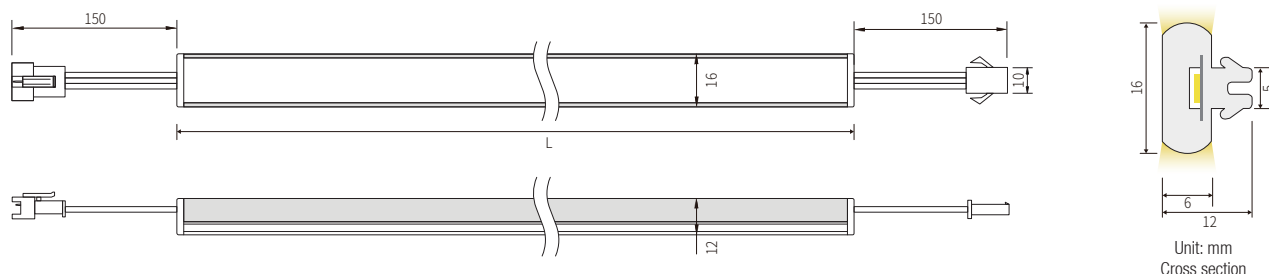

### Cable

Cable Type	Schematic Diagram	Specification	Core	Electrical Properties
PVC Cable		OD: 5.0mm	<span style="color: red;">●</span> <span style="color: green;">●</span> <span style="color: black;">●</span>	SPI: Red V+, Green DI/DO, Black V-

### RGB

Voltage (V)	Power (W/M)	CCT/Color	Lumen (LM/M)	Efficiency (LM/W)	Pixel (PCS)	Unit length (mm)	Signal Type	IC Model
DC24V	4.8	R	64	13.3	10	100	SPI	WS2811
	4.8	G	199	41.5				
	4.8	B	34	7.1				
	12.5	RGB	273	21.8				

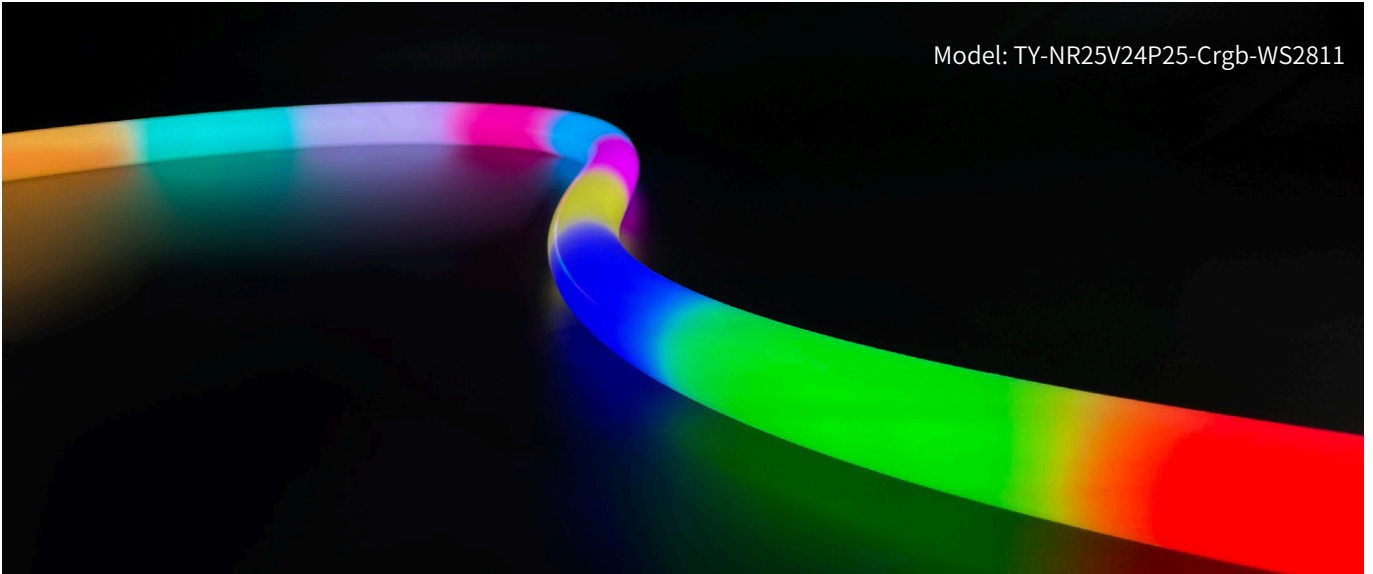

### Product Features

- It is made of Dow Chemical SILASTIC™ ET-7021 silicone rubber, which provides high transparency and high strength.
- Environmental protection grade silicone material, integrated extrusion molding process.
- Unique optical light distribution structure design, uniform lighting surface and no shadow.
- IP65 protection level, salt solution resistance, weak acid and alkali corrosion and UV.
- Excellent toughness, simple and stylish appearance, delicate and unique.
- 3 years warranty, working life  $\geq$  30000 hours;



Voltage  
24v DC



IP Level  
IP 65



UV  
Protection



Warranty  
3 Years

### Dimension structure

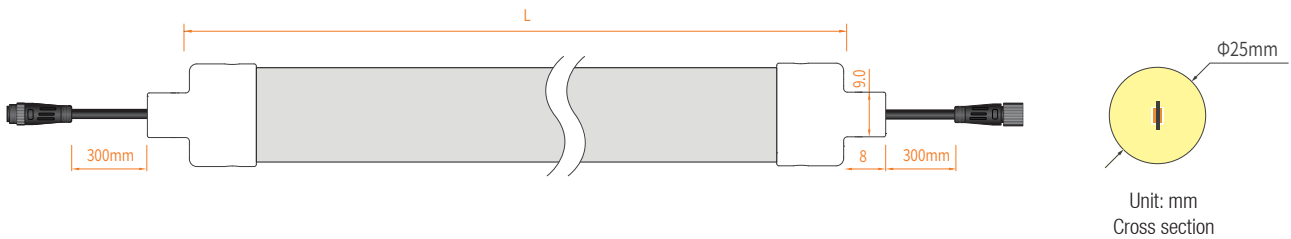

### Cable

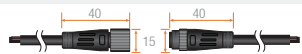
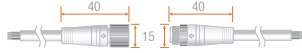
Cable Type	Schematic Diagram	Specification	Core	Electrical Properties
PVC Cable		OD: 5.0mm	● ● ●	SPI: Red V+, Green DI/DO, Black V-
Silicone Cable		OD: 5.0mm	● ● ●	SPI: Red V+, Green DI/DO, Black V-

### RGB

Voltage (V)	Power (W/M)	CCT/Color	Lumen (LM/M)	Efficiency (LM/W)	Pixel (PCS)	Unit length (mm)	Signal Type	IC Model
DC24V	9.6	R	112	11.7	10	100	SPI	WS2811
	9.6	G	350	36.5				
	9.6	B	54	5.6				
	25	RGB	474	19.0				



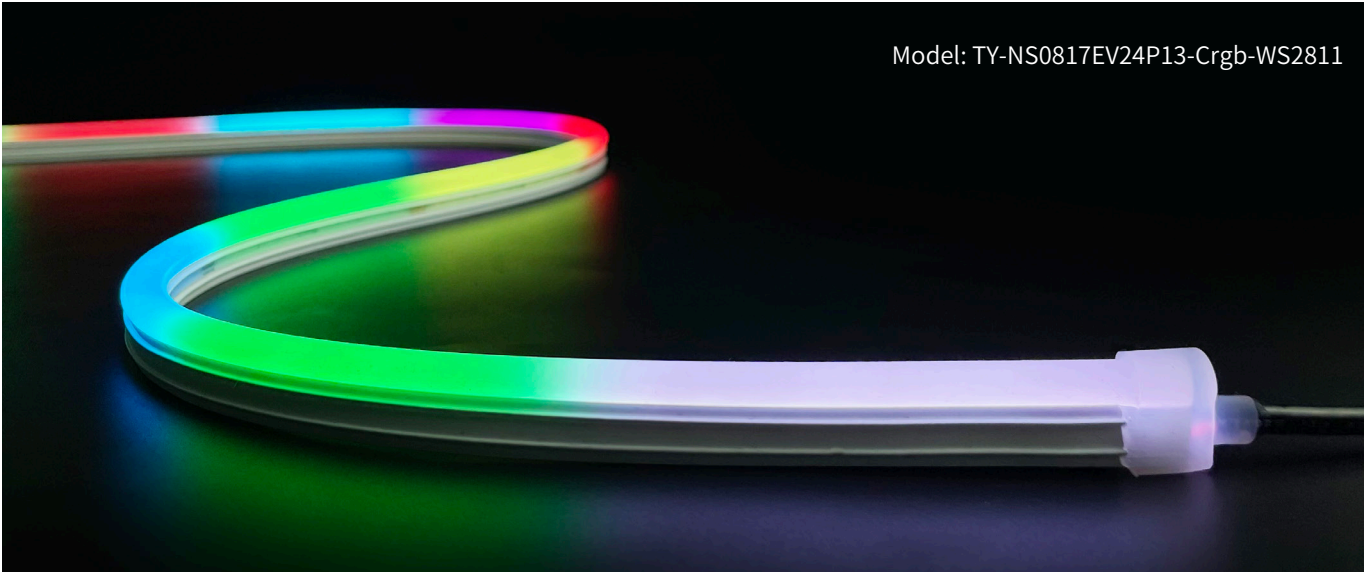

### Product Features

- It is made of Dow Chemical SILASTIC™ ET-7021 silicone rubber, which provides high transparency and high strength.
- Environmental protection grade silicone material, integrated extrusion molding process.
- Unique optical light distribution structure design, uniform lighting surface and no shadow.
- IP67 protection level, salt solution resistance, weak acid and alkali corrosion and UV.
- Excellent toughness, simple and stylish appearance, delicate and unique.
- 3 years warranty, working life  $\geq 30000$  hours;

Voltage  
24v DC

IP Level  
IP 67

UV  
Protection

Warranty  
3 Years

### Dimension structure

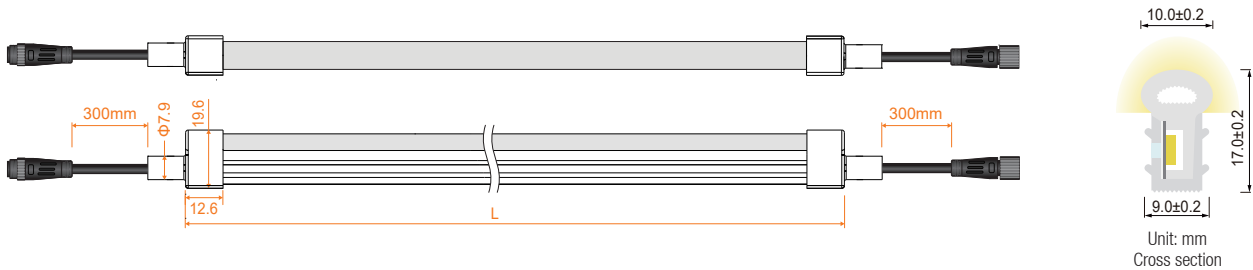

### Cable

Cable Type	Schematic Diagram	Specification	Core	Electrical Properties
PVC Cable		OD: 5.0mm	<span style="color: red;">●</span> <span style="color: green;">●</span> <span style="color: black;">●</span>	SPI: Red V+, Green DI/DO, Black V-

### RGB

Voltage (V)	Power (W/M)	CCT/Color	Lumen (LM/M)	Efficiency (LM/W)	Pixel (PCS)	Unit length (mm)	Signal Type	IC Model
DC24V	4.8	R	40	8.3	10	100	SPI	WS2811
	4.8	G	121	25.1				
	4.8	B	21	4.4				
	12.5	RGB	177	14.2				

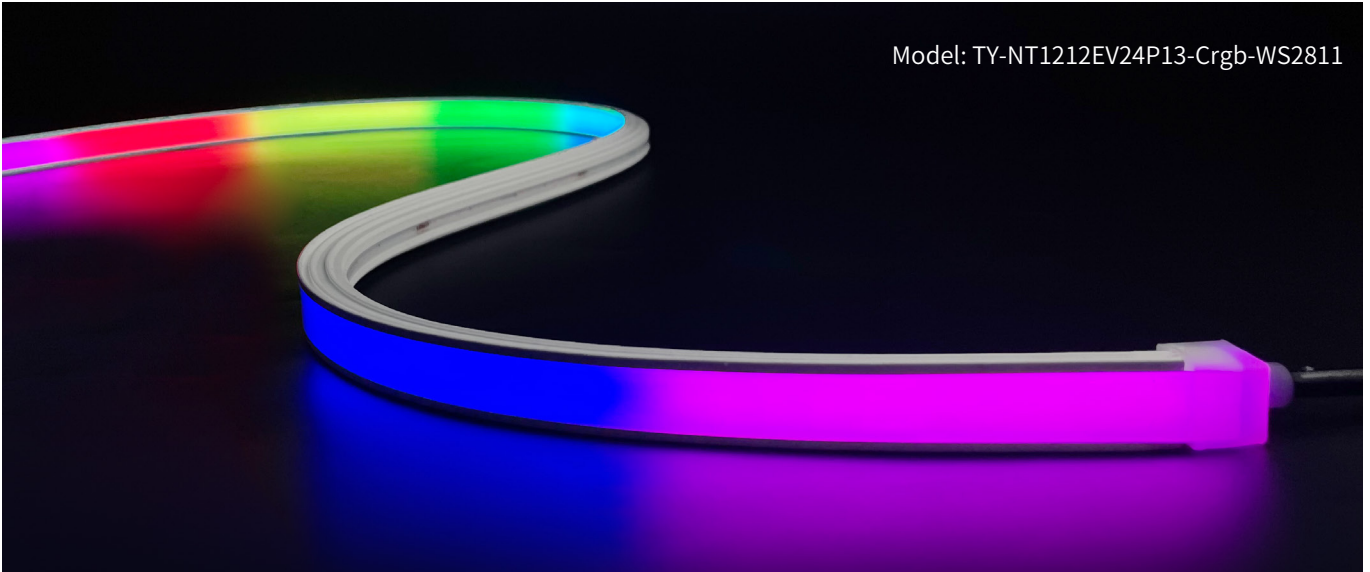

### Product Features

- It is made of Dow Chemical SILASTIC™ ET-7021 silicone rubber, which provides high transparency and high strength.
- Environmental protection grade silicone material, integrated extrusion molding process.
- Unique optical light distribution structure design, uniform lighting surface and no shadow.
- IP67 protection level, salt solution resistance, weak acid and alkali corrosion and UV.
- Excellent toughness, simple and stylish appearance, delicate and unique.
- 3 years warranty, working life  $\geq 30000$  hours;

Voltage  
24v DC

IP Level  
IP 67

UV  
Protection

Warranty  
3 Years

### Dimension structure

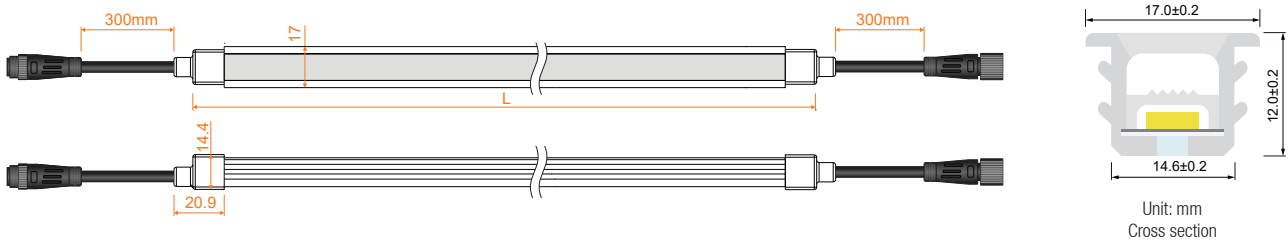

### Cable

Cable Type	Schematic Diagram	Specification	Core	Electrical Properties
PVC Cable		OD: 5.0mm	<span style="color: red;">●</span> <span style="color: green;">●</span> <span style="color: black;">●</span>	SPI: Red V+, Green DI/DO, Black V-

### RGB

Voltage (V)	Power (W/M)	CCT/Color	Lumen (LM/M)	Efficiency (LM/W)	Pixel (PCS)	Unit length (mm)	Signal Type	IC Model
DC24V	4.8	R	62	13.0	10	100	SPI	WS2811
	4.8	G	188	39.2				
	4.8	B	34	7.1				
	12.5	RGB	277	22.2				

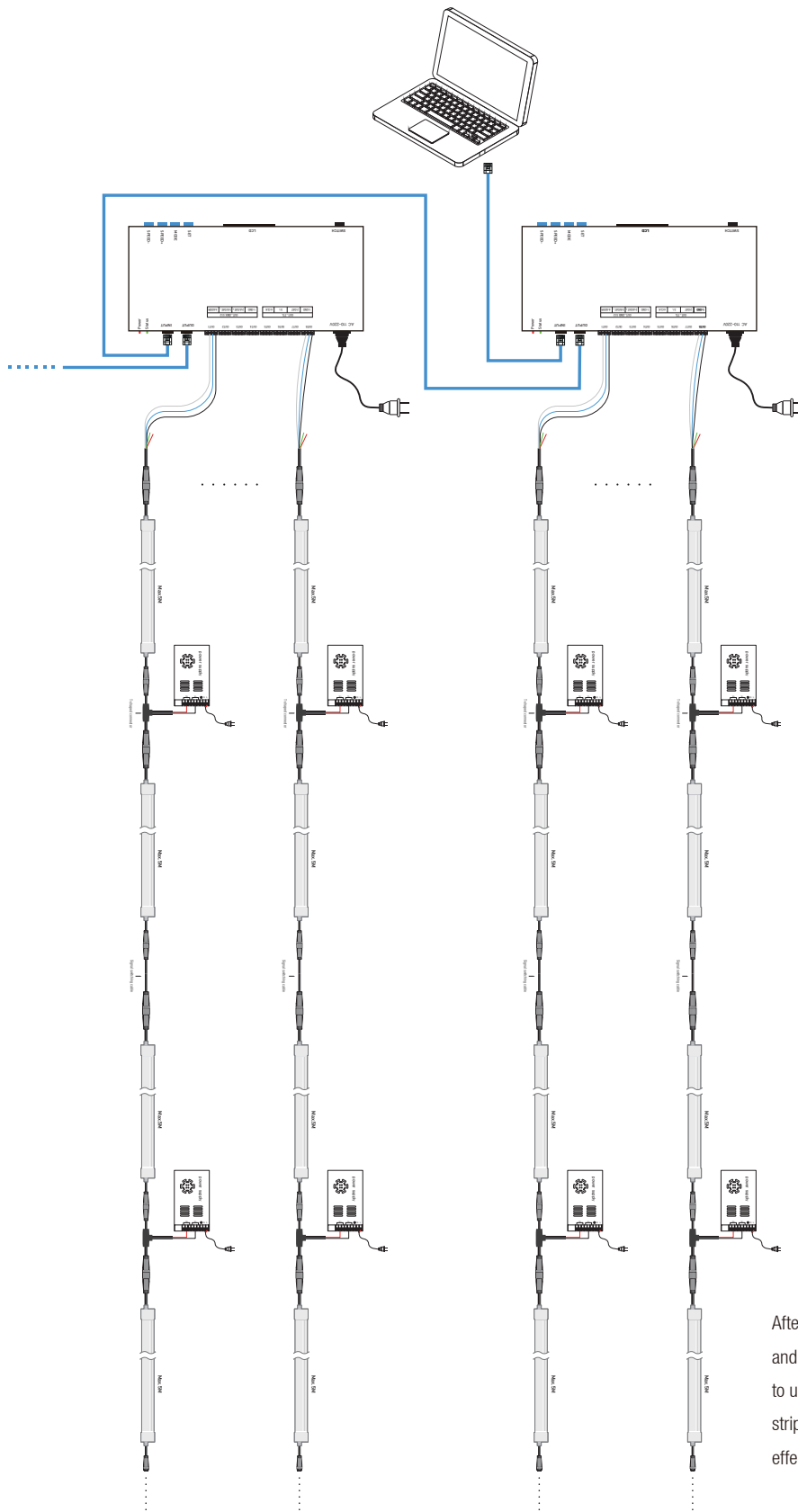

After the led strip is connected to the signal wire and power supply wire correctly, It is necessary to use a controller or order to address the led strip ,then the controller can run the control effect program.

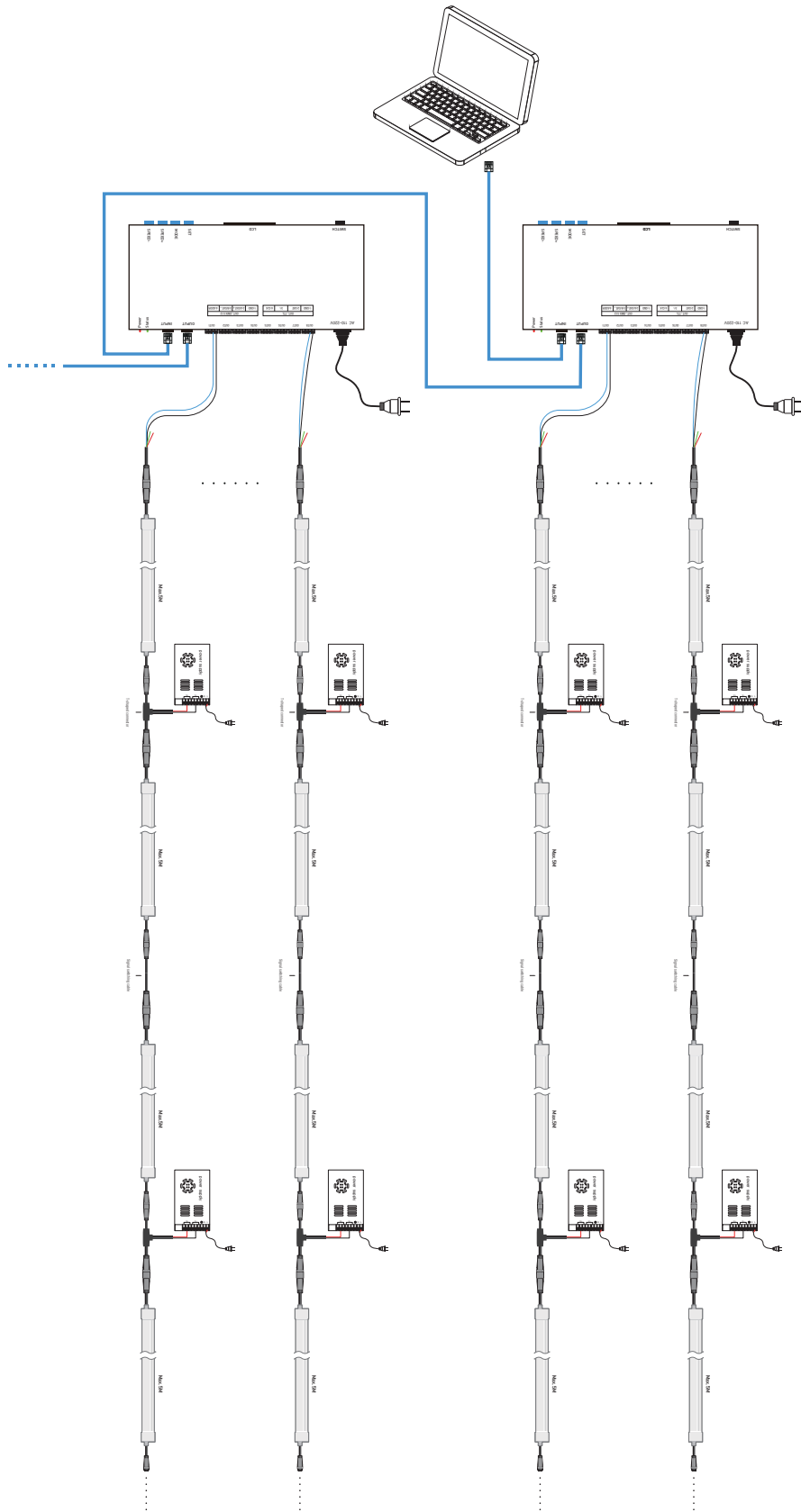

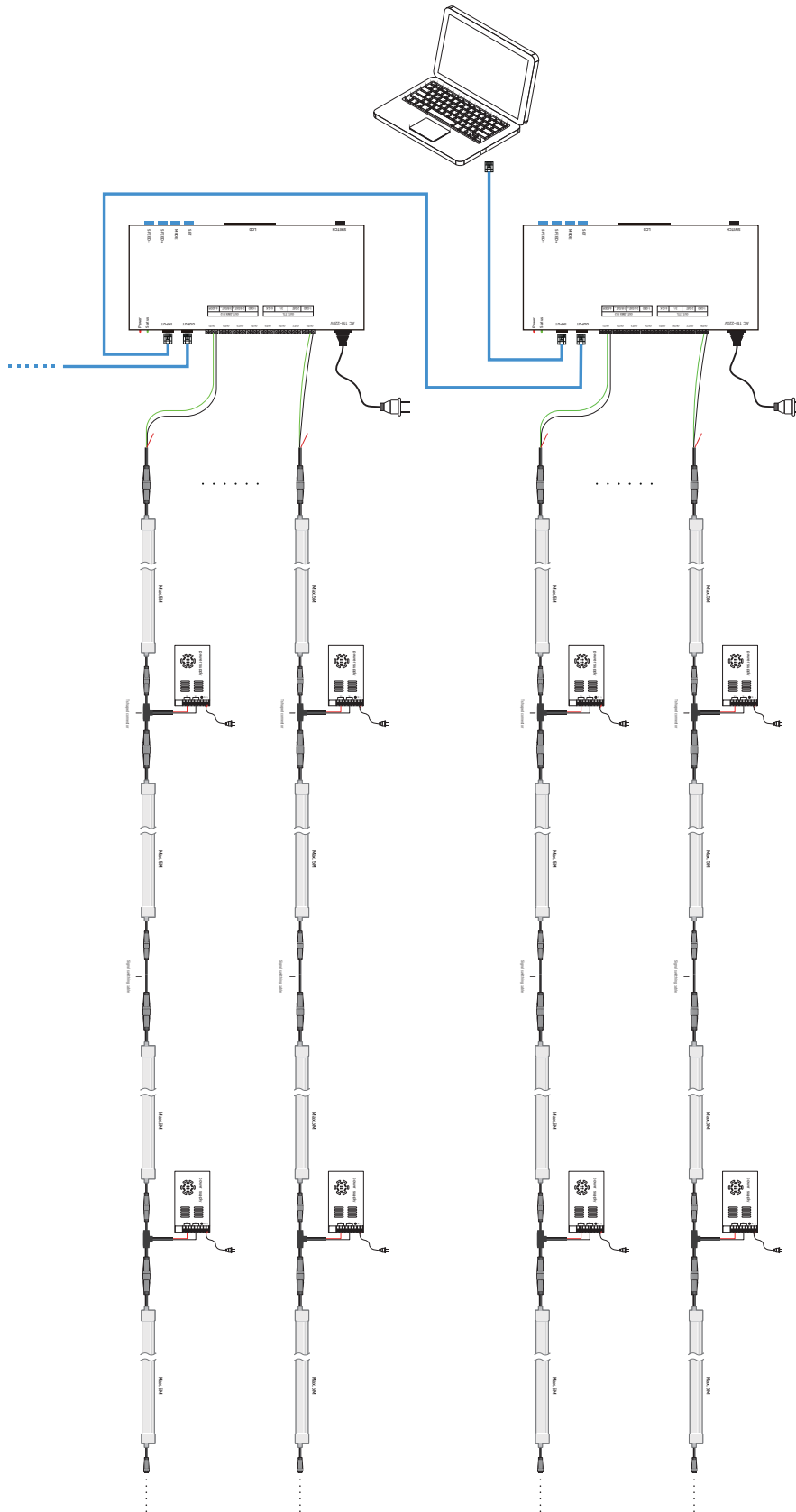

### T-type 3 channel connector

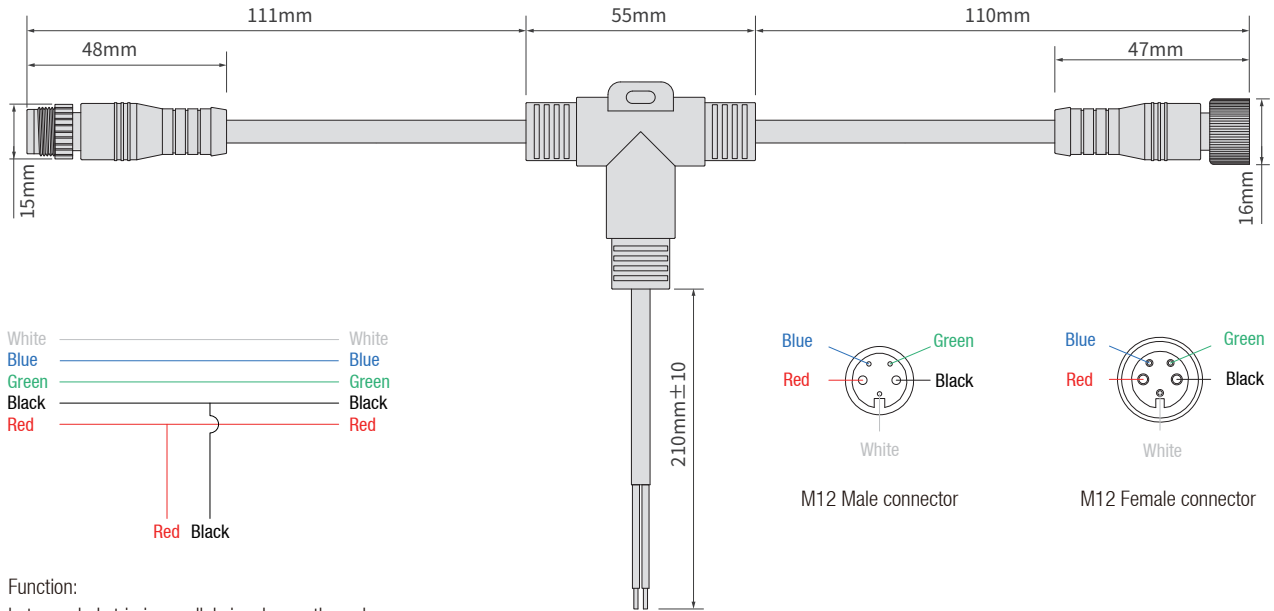

Function:  
between led strip in parallel, signal pass-through

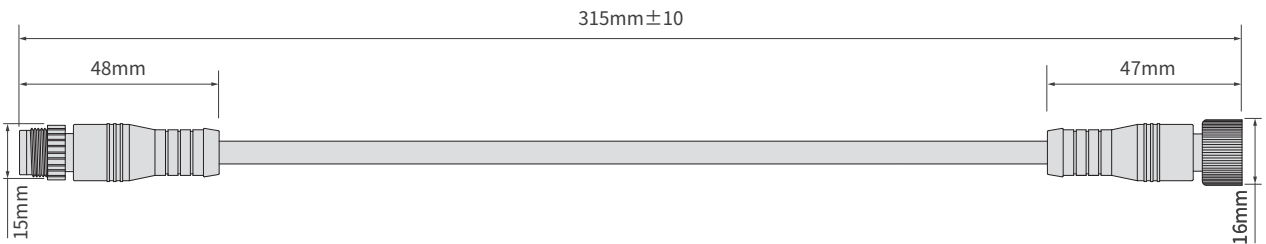

### Signal switching cable

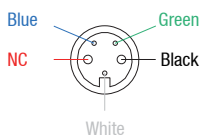

M12 Male connector

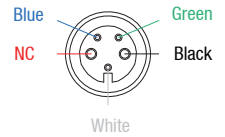

M12 Female connector

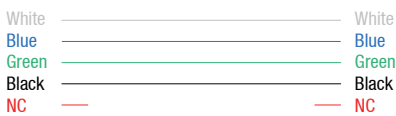

Function:  
Keep the signal cable connected in series;  
The positive terminal of the power supply is disconnected (avoid two power supplies connected in parallel).



### T-type 3 channel connector

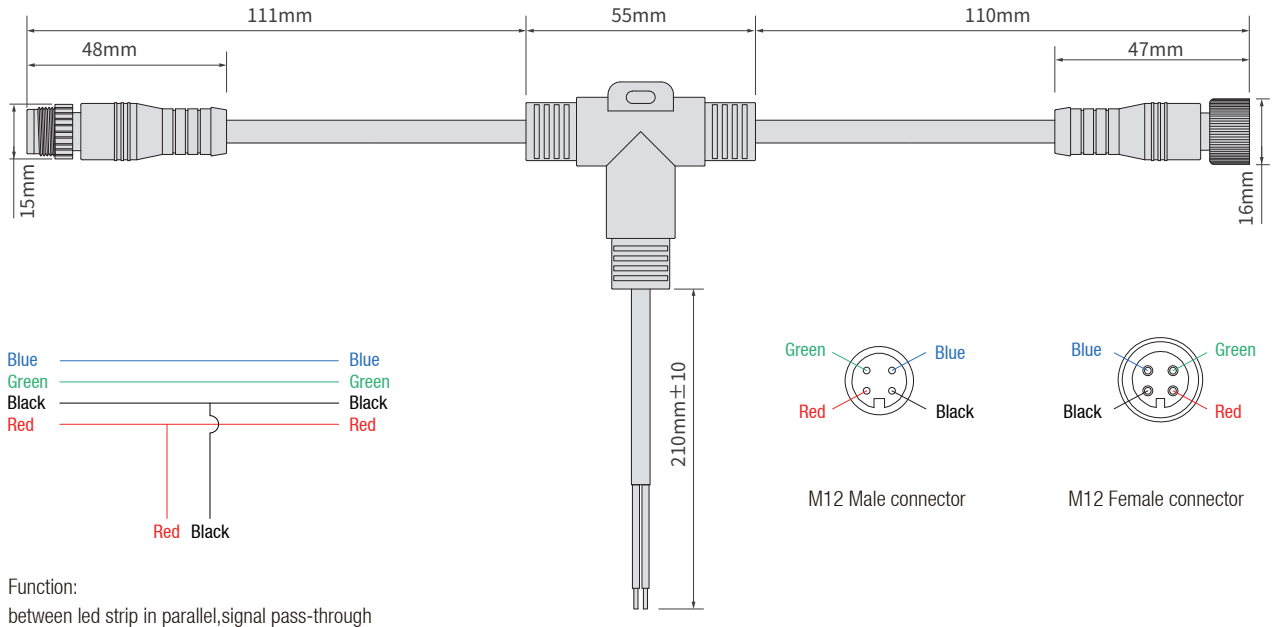

### Signal switching cable

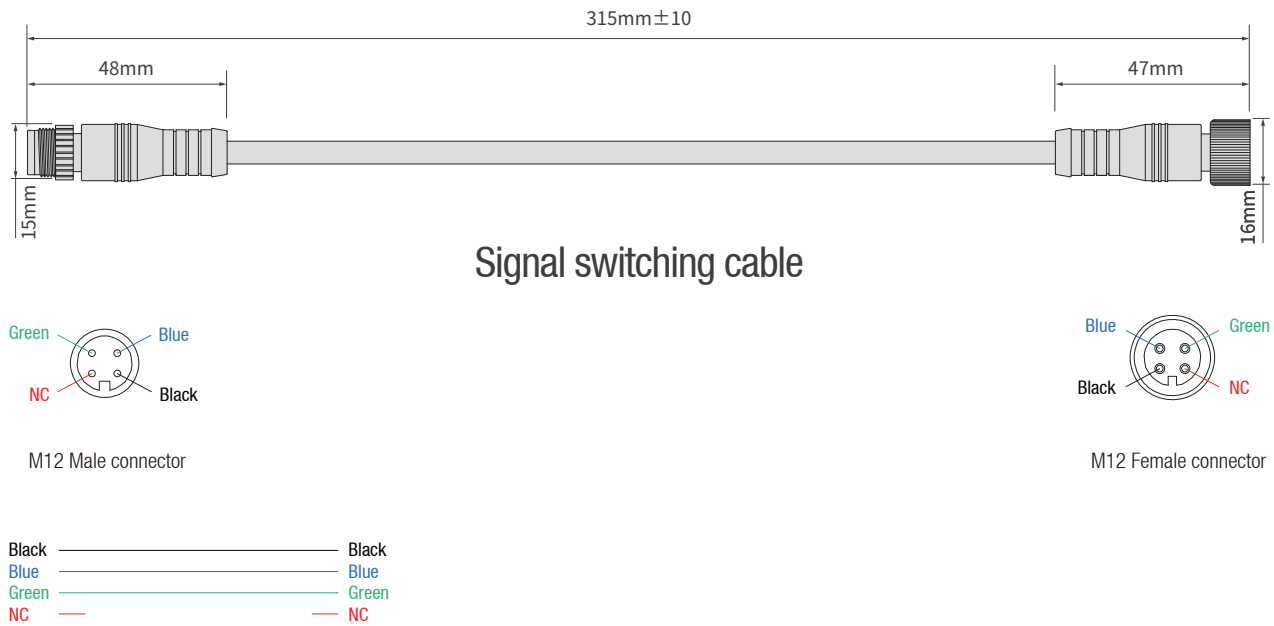

Function:  
 Keep the signal cable connected in series;  
 The positive terminal of the power supply is disconnected (avoid two power supplies connected in parallel).

### T-type 3 channel connector

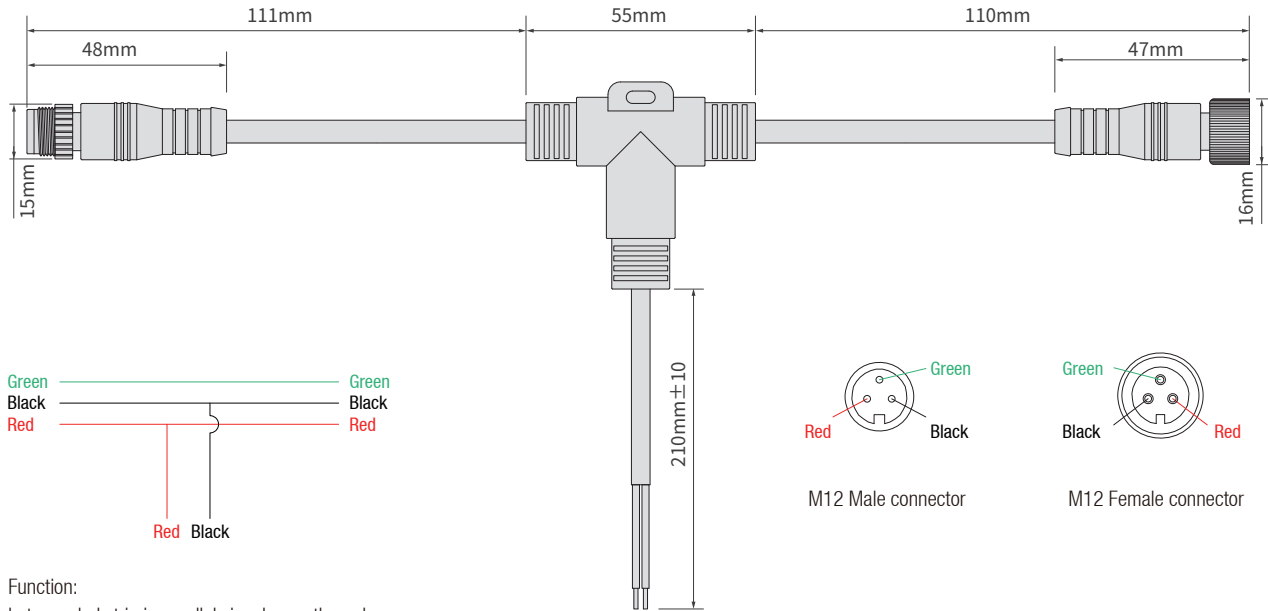

### Signal switching cable

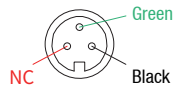
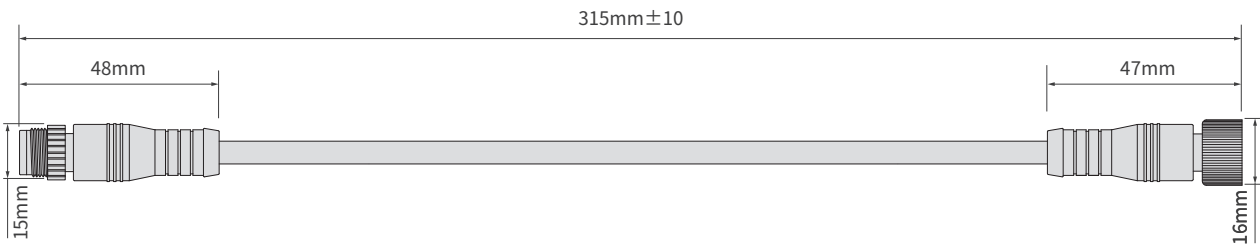

M12 Male connector

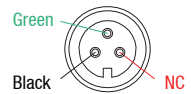

M12 Female connector



Function:  
 Keep the signal cable connected in series;  
 The positive terminal of the power supply is disconnected (avoid two power supplies connected in parallel).

### T-type 3 channel connector

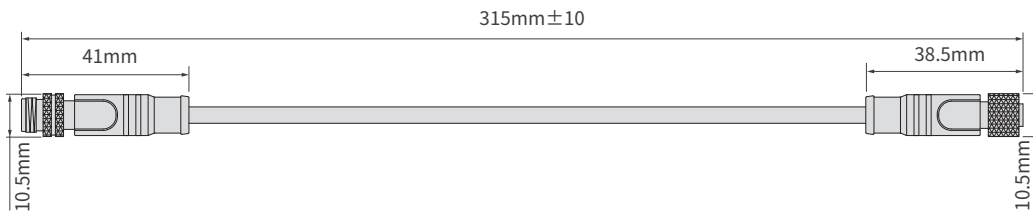
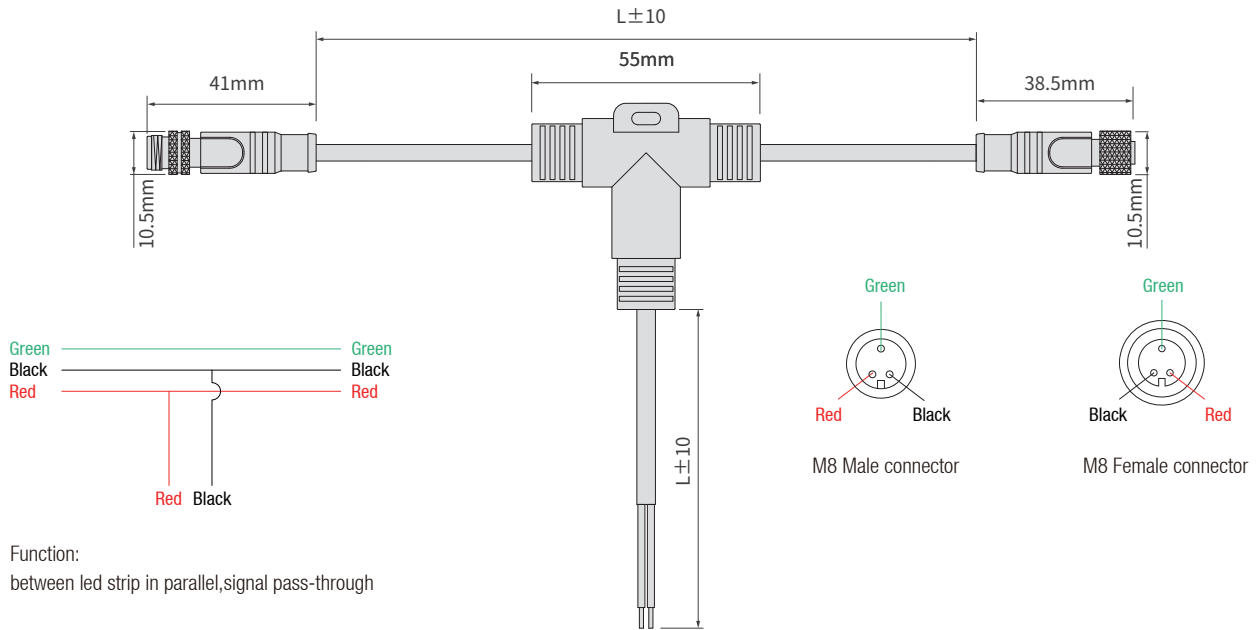

### Signal switching cable

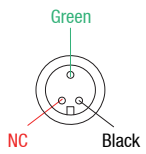

M8 Male connector

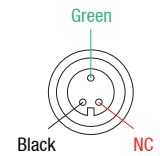

M8 Female connector



Function:  
Keep the signal cable connected in series;  
The positive terminal of the power supply is disconnected (avoid two power supplies connected in parallel).



Specialized  
LED strip Manufacturer

## TYRIA LIGHTING TECHNOLOGY CO., LIMITED



F1: 2F, D Building, Antonio Technology Park, Ma'anshan Community, Shajing Street, Baoan District, Shenzhen, Guangdong, China

F2: Shancheng Industrial Zone, Shiyan Town, Baoan District, Shenzhen, Guangdong, China



### OUR EMAIL

info@tyrialight.com



### OUR PHONE

Tel: 0755-36931652



### OUR WEBSITE

Web: www.tyrialight.com